

# **DOL SHITING TECHING LOGY**

METALLOGRAPHY



# CONTACTS



*POLISHING TECHNOLOGY®*

Located in Gaillard, LAM PLAN specializes in industrial lapping and polishing solutions.

For 60 years, LAM PLAN teams have been designing and providing equipment and preparations guaranteeing its customers performance, quality and productivity.



## SDS

Safety data sheets

Download all the safety data sheets in PDF format LAM PLAN according to the REACH and CLP regulations: (Classification Labelling Packaging).



[www.fdsen.lamplan.com](http://www.fdsen.lamplan.com)

## CATALOGS

The 4 catalogues in English

Download in PDF format LAM PLAN the LAM PLAN catalogs and find all the polishing technologies.



[www.caten.lamplan.com](http://www.caten.lamplan.com)

## MANUALS

Instructions for use

Download in PDF format the operating instructions and manuals of the different LAM PLAN machines and products.



[www.manen.lamplan.com](http://www.manen.lamplan.com)



## LAM PLAN SA

7 rue des Jardins  
BP 15  
74240 Gaillard - France

Tel. +33 (0)4 50 43 96 30  
Fax: +33 (0)4 50 87 01 60  
email: mmsystem@lamplan.fr

[www.lamplan.com](http://www.lamplan.com)



## VIDEOS

Machine and product films

Watch the videos of our different machines by scanning the QRcode located on the «machine» pages of this catalog using your smartphone and find all of our videos.



[www.viden.lamplan.com](http://www.viden.lamplan.com)

## Contact our technical team

email: [biodiamant@lamplan.fr](mailto:biodiamant@lamplan.fr)

## For all questions

Tel. +33 (0)4 50 43 96 30

## Social networks

Follow our news and events ...



Copyright © 2022 LAM PLAN. All Rights Reserved.

# LAM PLAN, SERVICES



## TESTING LABORATORY

Attentive to your need, we assist you regarding the process of defining and interpreting your expectations. The fine expertise of your demand combined to our best know-how enable us to shape a tailor made solution for you.



Take a virtual tour of our test centre on [www.360en.lamplan.com](http://www.360en.lamplan.com)



From the formal request to the detailed test report our CUSTOMER TEST CENTRE is at your disposal.



## Always gather the best of your investments

By choosing LAM PLAN 's equipment, you will benefit the service and monitoring of our technicians. As a machinery and consumable manufacturer, we provide our entire experience and resources for your satisfaction.



## Commissioning and Training

Our aim is for you to become immediately efficient and productive. We will train you in the use of the material and in the implementation of the included consumables.

## Preventive Maintenance

LAM PLAN offers you punctual preventive maintenance tasks or annual contracts designed for each machine. We provide regular monitoring of your machines profiting an optimised management of maintenance costs, minimising the frequencies of failures.

## The curative maintenance

In case of a failure which would cause the cessation of your production, the rapidity of reaction is preeminent. It mostly lays on the quality of the diagnosis and the availability of replacement parts. These curative maintenances are operated for all LAM PLAN's machinery.

## The Retrofit

Retrofit maintenances include the upgrade of old equipment in order to prolong their use or to comply with new standards.

We also assure you the installation of optional equipment to improve your material and adjust it to your requirements.

# FROM INNOVATION TO DESIGN AND MANUFACTURING

Your requirements are a constant source of innovation. The LAM PLAN technical team addresses all challenges and attempts to respond to specific issues in a simple way, that remains safe and comfortable to handle.

Our constant renewed ability to improve our machines, supports and products, combined with our original know-how, enable us to respond to all demands.

Lapping, polishing, metallography: mastering these 3 lines of business empowers us to respond the most varied customer demands. Our know-how is spread into each distinct sector, through an overview of the volume of solutions.



## Supports

Plates, rods, abrasive discs, polishing pads, we develop a full range of supports making it possible to reach any surfaces and remove the required matter.



## Abrasive solutions

Preparations in the form of pastes and liquids, conventional and diamond abrasives, we develop formulations that respect the health of users and preserve the environment without compromising efficiency.



## Machines

Whether your needs go for lapping, polishing or metallography, our range of machines and peripheral devices offer you a complete equipment to treat all type of parts.

## Quality assurance

The ISO 9001 certification constitutes the base of our approach to perpetual enhancement and concern about customer's needs, which enables us to respond to it properly. This certification of quality management within our organisation guarantees a permanent monitoring of our system's performance, quality of our products and services. Our goal: The customers' satisfaction.

COMPANY CERTIFIED  
**ISO 9001**

PROMOTES THE CERTIFICATION  
**ISO 14000**

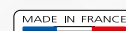

# TABLE OF CONTENTS

## CUTTING

CUTTING MACHINES	CUTLAM®micro 1.1		6
	CUTLAM®micro 2.0		7
	CUTLAM®micro 3.0		8-9
	CUTLAM®1.1		10-11
	Support cabinet		11
	CUTLAM®3.1		12-13
	CUTLAM®4.0		14-15
	CUTLAM®5.0		16-17
	Vices, clamping and accessories		18-19
	Oil mist extraction device A1	NEW	20
Filters, refractometer and cutting fluid 723	NEW	21	
CUT-OFF WHEELS	Excellence, Precision and Precision Diamant cutting wheels	NEW	22-25
	Adaptor rings		25

## MOUNTING

MOUNTING MACHINES	PRESSLAM®1,1		26-27
	Mounting devices M.M.808 and M.M.818	NEW	28
HOT MOUNTING RESINS	PHENOFREE resins		29
	Unmoulding agent SOLILUB		29
	Epoxy resins 633 & 634		30
	Acrylic resins 616 & 616.2		30
	Copper resin 604.3		30
	Graphite resin 617		31
COLD MOUNTING RESINS	Acrylic resin 601.2		32
	Transparent Epoxy resins 603 & 603.2		32
	Polyester resins 605 & 607		33
	Transparent Methyl methacrylate resins 609 & 609 Plastichrome		33
	Methyl Methacrylate resin 655	NEW	34
ACCESSORIES	Polymerisation lamp M.M.866		35
	ISOFORCE	NEW	35
	Cold mounting moulds and universal sample-holder moulds 610		35-36
	Cups and spatulas, micro engraver M.M.886		36
	Charge element for resin mould, Epochrome powder and removal agent	NEW	37
	Blade-holders and holding clips		37

## PREPOLISHING & POLISHING

PREPOLISHING MACHINE	RECTILAM® 2.0		38-39
POLISHING MACHINES	SMARTLAM® 2.0		40
	SMARTLAM® 3.0		41
	MASTERLAM® 1.0		42
	MASTERLAM® 3.0		43
	MASTERLAM® 1.1		44
	Dosing unit DISTRILAM® & transparent protective housing		45
	Plates, sample holders, clamping rings		46
	Diaphragm compressor and filter kit		47
	Universal sample-holder mould		47

<b>FIXING ACCESSORIES</b>	FAS®2 discs, FMS, FIX LAM®, XLAM 4 and XLAM 4-M discs and plates	<b>NEW</b>	48-49
<b>CLEANING &amp; STORAGE ACCESSORIES</b>	BOX LAM® and accessories		50
	COVER LAM®		51
	Ultrasonic tanks M.M.80 and 275, detergent 742, technical wipings		51
<b>GRINDING &amp; PREPOLISHING DISCS</b>	SiC abrasive papers		52-54
	Grinding wheels		54
<b>GRINDING &amp; PREPOLISHING DISCS CAMEO®DISK</b>	CAMEO®DISK Platinum		55-56
	CAMEO®DISK Silver, Gold & Rhodium	<b>NEW</b>	57
	Abrasive stones & Diamond dressing tool		56-57
<b>POLISHING SUPPORTS</b>	TOUHLAM® cloths: Ø 200 to 400 mm		58-61
<b>DIAMOND ABRASIVE SUSPENSION</b>	Bio DIAMANT® liquids NEODIA®M, NEODIA®P, NEODIA®F		62-64
	Bio DIAMANT® M.M.140		64
	Manual distributors to be filled		64
	Pulmatic Bio DIAMANT® 310 & 320P		65
	Finishing liquids SUPERFINISH, FINAL, L1, L2 and ALPLAN		66
	Bio DIAMANT® sticks - Series 122 and 123P		67
	Bio DIAMANT® pastes - Series 100		68
<b>LUBRICANTS</b>	Lubricants M.M.702 & 704		69
	Booster for CAMEO®DISK Platinum		69
<b>REAGENTS</b>	Metallographic reagents		70-71

## LITHOPREPARATION

<b>IMPREGNATION</b>	Vacuum impregnator device M.M.818 and precision sample holder PE128	<b>NEW</b>	72
<b>ROUGHING &amp; POLISHING</b>	M.M.8400 with PE128, MASTERLAM® 3.0 with thin slide holder	<b>NEW</b>	73

# 55 YEARS OF PASSION

FOR INNOVATION  
DEDICATED TO OUR CUSTOMERS

LAM PLAN S.A. was awarded the TALENT INPI trophy by the National Institute of Industrial Property.

This distinction is awarded to SME-SMI companies that innovate and include industrial property in their development strategy and growth plans.



# CUTTING



CUTTING MACHINES

## CUTLAM®micro 1.1

MADE IN FRANCE

The CUTLAM®micro 1.1 is a LAM PLAN laboratory micro-cutting machine. Easy to use and economical. It is designed for precision cuts of the most sensitive materials.

The CUTLAM®micro 1.1 allows you to include a versatile and robust machine in your laboratory at a reasonable budget. Its speed range and cutting chamber capacity will enable you to use it for many applications with a variety of cutting wheels (diamond,  $Al_2O_3$ , etc.) up to 150 mm diameter.

The work piece is held by a vice-holding, the knob, located outside of the cutting chamber, which permits a micro metric movement of the Z-axis.

The cutting feed is controlled with a sliding weight system, allowing you to fine-tune the load applied for delicate and slow cuts.

Equipped with an independent decanting/ recirculation tank, you can easily make slow cuts in optimum conditions of cooling.

Based on a robust aluminium frame with a painted metal body, the CUTLAM®micro 1.1 is stable and vibration free. The hinged transparent hood avoids any spraying outside the machine and allows easy access for clamping vices on the arm. The hood is fitted with a safety device which stop immediately the cutting wheel motor in case of an opening.



## CUTLAM®micro 1.1

Laboratory micro cutting machine  
Ø 150 mm



Recirculation coolant system, 10 litres

### Included Equipment

- Recirculation coolant system, 10 litres
- Cylindrical sample holder with clamping screw: Ø 12 to 50 mm maxi
- Set of flanges Ø 50 mm for cut-off wheels Ø 125 to 150 mm

### Accessories

- Set of flanges Ø 35 mm for cut-off wheels Ø 75 to 100 mm 60 CTM01 10
- Sample holder with multi screw clamping for irregular parts 60 CTM03 50
- Sample holder vice with clamping screw: Ø 12 mm maxi 60 CTM03 30
- V sample holder with clamping screw: Ø 24 mm maxi 60 CTM03 20
- Sample holder double vice with clamping screw: Ø 12 mm maxi 60 CTM03 40
- Cylindrical sample holder with clamping screw: Ø 12 mm to 50 mm 60 CTM03 10
- Small vice with clamping screw: Ø 12 mm 60 CTM02 10

Technical data	CUTLAM®micro 1.1
Wheel Ø	75 to 150 mm
Shaft Ø	12,7 mm
Standard flanges Ø	50 mm
Lateral arm displacement	Stroke 25 mm (accuracy 0,02 mm)
Preload weight	1 x 200 g
Vertical movement	Manual
Lubrication/Cooling	Recirculation system, 10 litres, 800 L/ hour pump driven by the machine
Motor power	0,18 kW
Rotational speed	Variable, from 50 to 1500 rpm
Body	Steel coated with epoxy paint
Protection	Transparent cover with locking system
Voltage	230 V - 50 Hz single phase
Dim. W x H x D	390 x 390 x 340 mm (H cover open: 630 mm)
Weight	25 kg
Reference	60 CTM10 00



Faced with the constant evolution of the materials and the quality standards, LAM PLAN is a reference partner for the preparation of the samples for the metallographic analysis.

Our technical solutions and our customised methods will ensure you reliable and reproducible results. We are fully committed to the quality of the samples.

## CUTTING MACHINES

**CUTLAM®micro 2.0**

MADE IN FRANCE

The CUTLAM®micro 2.0 is a compact laboratory micro-cutting machine intended for the most sensitive materials. The speed range and cutting chamber capacity make this machine incredibly versatile.

The sample is held in position using a vice-tightened holding arm and the wheel located outside the cutting chamber enables a micrometric movement along the Z axis; the movement can be tracked directly on the screen (accurate to 0,02 mm) Thanks to the zeroing system, very accurate parallel cuts can be performed.

A wide range of vices is available, enabling you to clamp any type of component or material. The cutting progress is either controlled manually or with a counterweight system specially adapted for delicate cuts. A rocker arm balances the implement weight, and another one permits to adjust the applied load with precision.

Fitted with a large-capacity (10 litres, large for the machine's size), independent filtration/decanting/recirculation tank, it is easy to perform long cuts under ideal cooling conditions. The CUTLAM®micro 2.0 has been designed to simplify maintenance and cleaning operations, the base of the cutting chamber is equipped with an inlet filter to prevent the loss of small parts and components. A 100 µm fabric filter at the decanter inlet filters out the largest particles, and the remainder of the filtration is accomplished by decanting into a compartmented tank.

Built upon a robust, mechanically welded chassis sheathed with a painted sheet-steel body, the CUTLAM®micro 2.0 is particularly stable and is not prone to vibration, saving you valuable laboratory work space.

Technical data	CUTLAM®micro 2.0
Wheel Ø	75 to 200 mm
Shaft Ø	12,7 mm
Standard flanges Ø	50 mm
Lateral arm displacement	Stroke 80 mm (accuracy 0,02 mm)
Preload weight	2 x 200 g
Vertical movement	Manual
Motor power	0,6 kW
Rotational speed	Variable, from 200 to 4000 rpm
Protection	Transparent cover with locking system
Touch screen 3,5"	Intuitive and graphic interface
Voltage	230 V - 50 Hz single phase
Dim. W x H x D	430 x 300 x 450 mm (H cover open: 644 mm)
Weight	40 kg
Reference	60 CTM20 00

**CUTLAM®micro 2.0**

Laboratory precision  
micro cutting machine

**Included Equipment**

Recirculation system, 10 litres,  
2 compartment decantation tank, 100 µ fabric filter, recirculation pumps  
800 L/hour driven by the machine

Cylindrical sample holder with clamping screw: Ø 12 to 50 mm

Set of flanges: Ø 50 mm for cut-off wheel: Ø 125 to 150 mm

**Options**

Slow speed 50 to 1000 rpm 60 CTM 20 20

Vacuum system for holding thin sections 60 CTM 03 80

**Accessories**

Set of flanges Ø 35 mm for cut-off wheels Ø 75 to 100 mm 60 CTM01 10

Set of flanges Ø 75 mm cut-off wheels until Ø 200 mm 60 CTM01 30

Sample holder with multi screw clamping for irregular parts 60 CTM03 50

Sample holder double vice with clamping screw: Ø 12 mm max 60 CTM03 30

V sample holder with clamping screw: Ø 24 mm maxi 60 CTM03 20

Sample holder double vice with clamping screw: Ø 12 mm max 60 CTM03 40

Cylindrical sample holder with clamping screw: Ø 12 mm to 50 mm 60 CTM03 10

Small vice with clamping screw: Ø 12 mm 60 CTM02 10

Medium vice with clamping screw: Ø 24 mm 60 CTM021 10



## CUTLAM® micro 3.0

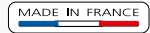

The CUTLAM® Micro 3.0 is designed for laboratories looking for an automatic machine adapted to high precision, long and difficult cuts.

This benchtop designed cutting machine offers astonishing capacities. Thanks to the multiple motion table, the cutting wheel, and the feed speed control system according to the cutting torque, this machine will overcome any difficult task.

### Large capacity compact cutting machine

It is fitted with a large: 320 x 540 mm chamber, and equipped with a grooved aluminium table, sized 210 x 210 mm, and stainless steel interchangeable pallets.

The large capacity of the CUTLAM® micro 3.0 relies on the use of 200 mm cut-off wheel, combined with a vertical movement range of 100 mm (Z axis) and a longitudinal range of 270 mm (Y axis).

### Precision

The positioning of the axes, which can be seen on the screen is 0,01 mm accurate and feed speed while cutting can be set from 0,1 to 20 mm/sec or 0,1 to 10 mm/sec.

The use of the "smart motion" (read the following page about this device) will automatically reduce the moving of the axes in order to obtain a minimum value of 0,02 mm/sec.

### User-friendly interface

A large touch-screen allows you to select the different functions using an easy to use, intuitive interface. All the positioning and cutting parameters can continuously be visible on the screen. The use of a joystick allows a fast positioning of the cut-off wheel; while in automatic and semi-automatic modes, an estimation of the remaining cutting time appears.

Three cutting modes are available: manual, semi-automatic and automatic.



## CUTLAM® micro 3.0

High-precision automatic 2 axes\* cutting machine

\*optional 3rd (X)



300 programs can be stored in the built-in memory, including: start position, feed speed, rotational speed, cutting mode.

Theoretical cutting capacity - Ø 200 mm \*space under wheel

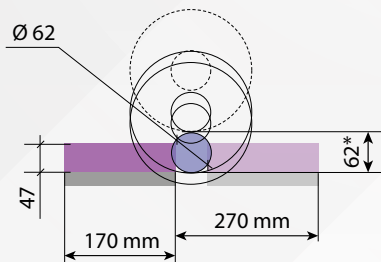

## CUTTING MACHINES

**Efficiency: 5 key points for higher productivity**

1. Powerful motor of 1,1 kW.
2. Sequential cutting mode for a maximum cooling.
3. Ingenious feed speed control:
  - The feed speed is pre-set, and will be automatically reduced if the load on the cutting wheel increases. The pre-set speed returns when the load on the wheel decreases.
  - It improves the quality of the cut by limiting the heat damages on the samples.
  - Suitable for irregular samples and/or materials with heterogeneous hardness.
  - It prevents the wheel from breaking in case of overload.
  - It allows you to always work at maximum speed without any risk of damage.
4. Optional cross-feed table (X axis) manual or motorised for repetitive parallel cuts.
5. Independent lubrication/cooling system, composed of a 100 µ washable filter, and a 30 litres sedimentation tank with multi-point nozzle, insures excellent cooling of the sample and the cutting wheel even during intensive use.

**Options**

Manual cross-feed table (X axis) to cut parallel sections stroke 55 mm accurate to 0,01 mm	60 CTM31 00
Motorised cross feed table (X axis) to cut parallel sections stroke 50 mm, accurate to 0,01 mm	60 CTM34 00
Positioning laser	60 CTM35 00

Technical Data	CUTLAM®micro 3.0
Wheel Ø	75 to 200 mm
Shaft Ø	12,7 mm
Standard flanges Ø	75 mm
Passage under the wheel	62 mm (with a Ø 200 mm wheel)
Max cutting capacity	Ø 62 mm (with a Ø 200 mm wheel)
Vertical movement	Z axis 100 mm automatic
Longitudinal movement	Y axis 270 mm automatic
Transversal movement	X axis 55 mm manual or 50 mm motorised (optional)
Cooling/ Lubrication	Decantation tank, 2 chambers, Input 100 µm filter, Pump 800 L/hour driven by the machine.
Motor power	1,1 kW
Rotational speed	Variable, from 1000 to 4000 rpm.
Cutting modes	Manual, semi-automatic, automatic
Feed speed control	0,1 to 20 mm/sec. programmable Automatic control of speed / power continuous or sequential
Lightening	LED
Protection	Transparent cover with locking system
Voltage	230 V - 50 Hz simple phase
Dim. W x H x D	620 x 470 x 750 mm (H cover open 812 mm)
Weight	80 kg
Reference	60 CTM30 00

**Tool for axial cutting of Ø 4 mm parts.**

This device, used in conjunction with quick release clamps, enables manual positioning following the X axis, ensuring cutting precision and repeatability.

NEW

60 CTM03 93

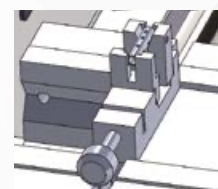

60 CTM35 00



60 CTM31 00



60 CTM34 00



60 CTM01 10/20/30



60 CT200 40



60 CTM36 00



60 CTM32 00



60 CTM33 00



60 M0100 00

**Accessories**

Set of flanges Ø 35 mm for cut-off wheels Ø 75 to 100 mm	60 CTM01 10
Set of flanges Ø 50 mm for cut-off wheels Ø 125 to 150 mm	60 CTM01 20
Set of flanges Ø 75 mm for cut-off wheels until Ø 230 mm	60 CTM01 30
Independent double vice (right and left) screw tightening	60 CT200 40
Right vice with fast tightening, small model	60 CTM32 00
Left vice with fast tightening, small model	60 CTM33 00
Buckle fastener Kopal 54	60 CTM36 00
Cabinet: 1 drawer, 1 storage in the door + integration of the recirculation tank	60 M0100 00



**CUTLAM<sup>®</sup> 1.1**

Manual cutting machine  
vertical motion

#### Theoretical cutting capacity - Ø 305 mm

*\*space under wheel*

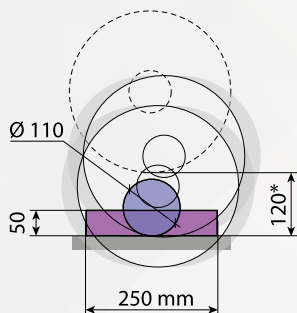

## CUTLAM<sup>®</sup> 1.1

MADE IN FRANCE

The CUTLAM<sup>®</sup> 1.1 is a bench-mounted cutting machine for a wide range of applications. Robust and easy to use, with a deported motor design, this machine has a very large cutting capacity. It allows you to equip your laboratory with a simple, versatile and reasonably-priced machine made from high-quality components.

This machine offers a spacious cutting table, made of treated anti corrosive cast iron. It is also easy to handle with a fully opening cover and remote motor. The 4 perpendicular grooves enable you to clamp components of thicknesses up to 120 mm. The CUTLAM<sup>®</sup> 1.1 can be equipped with Ø 250 to 305 mm cut-off wheels.

Fitted with a speed adjuster and a powerful 3.8 Kw motor particularly adapted to Ø 305 mm wheels, the CUTLAM<sup>®</sup> 1.1 is perfect for intensive use.

The high-capacity recirculation system with pre-filter and de-canter compartments ensures optimum lubrication and cooling by a multi-point spray.

The cutting chamber is illuminated by a strong and trendy aluminium projector.

The protection cover is made of two parts: a large glass area, giving a complete visibility on the cutting chamber, and a lacquered metallic belt offering a high resistance to this protection core. Furthermore, thanks to an interlocking system, this cover locks itself when the wheel is in rotation.

This machine is offering 2 lateral openings, giving the possibility of cutting bars which have a 60 mm diameter.

An external shower head combined with a tilted cutting chamber base makes cleaning easy, and an inlet filter ensures that your samples do not fall down the large-diameter outlet pipe.

Technical Data	CUTLAM <sup>®</sup> 1.1
Wheel Ø	250-305 mm
Shaft Ø	25,4 mm
Standard flanges Ø	80 mm
Max cutting capacity	Ø 110 mm (Ø 305 mm wheel)
Passage under the wheel	120 mm (Ø 305 mm wheel)
Vertical movement	Manual
Lubrication	Recirculation system, 60 litres, on casters, integrated cleaning system, with shower head located outside the cutting chamber
Motor power	3,8 kW
Rotational speed	Variable, from 1000 to 4000 rpm
Table	Groove treated stainless steel, 400 x 300 mm
Type of groove	T groove 12 mm (2 longitudinals, 2 transversals)
Lightening	LED
Protection	Transparent cover with locking system
Body	Epoxy painted coated steel
Voltage	400 Volts - 50 Hz (three-phase)
Dim. W x H x D	630 x 650 x 820 mm - H opened cover: 820 mm
Weight	125 kg
Reference	60 CT110 00

## CUTTING MACHINES

**Example of application: cutting of a sphere**

One of the recurrent issues remaining in the cutting processes is the clamping of spherical parts. The implementation of this kind of vice on the CUTLAM® 1.1 enables to cut spheres having a diameter going from 30 mm to 60 mm.

**Example of application: cutting of a glass cylinder with double wheel**

Tooling allowing the removal of a 3 mm slice from a glass cylinder Ø 50 mm, height 50 mm. This article includes the supply and installation of a specific clamp and a double grinding wheel on a CUTLAM® 1.1 machine.

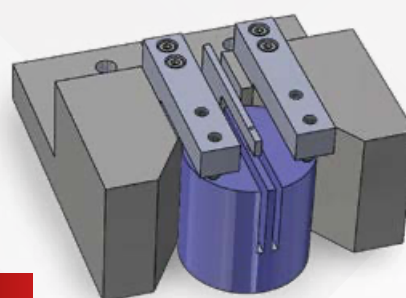

NEW

**Accessories**

Fast tightening double vice system	60 CT200 20
Screw tightening double vice system	60 CT200 40
Universal clamping vice KOPAL 61	60 081282 20
Clamping flange adjustment	60 081282 40
Long shaft for clamping flange KOPAL	60 00285 90
Cabinet: 1 drawer, 1 storage + integration of the recirculation tank	60 M0100 00
Universal table (X axis) for parallel cuttings	60 CT205 20
Stainless steel table in option	60 CT211 200
Aspiration/filtration set (see specific page)	60 CT204 00



60 081282 40



60 00285 90



60 081282 20



60 CT206 20



60 CTC20 520



Recirculation system 60 L



60 CT200 40



60 CT200 20



Interlocking

**CUTLAM® support cabinet**

**Solid painted-steel piece of furniture specially designed for CUTLAM® products.**

It contains a storage door for tools and cut-off wheels, a drawer on top and a space for the recirculation tank. This piece of furniture is stable and has adjustable feet.

**For CUTLAM® micro 3.0 and CUTLAM® 1.1**  
**Dimensions W x H x D: 630 x 800 x 835 mm.**  
**Reference: 60 M0100 00**

**For CUTLAM® 3.1**  
**Dimensions W x H x D: 700 x 800 x 1050 mm.**  
**Reference: 60 M0310 00**





## CUTLAM® 3.1



The CUTLAM®3.1 is the ultimate development of LAM PLAN and is the most advanced automatic  $\varnothing$  300 mm cut-off machine in its market sector.

### Largest cut-off area on the market of $\varnothing$ 300 mm cut-off machines

The CUTLAM®3.1 offers an unprecedented cutting capacity, the machine table can move forward and backward automatically over a distance of 300 mm. New, the cut-off wheel has an automatic and linear top-to-bottom movement. With this linear movement, this new-generation of cutting machine offers a 140 mm space under the cutting wheel. The CUTLAM®3.1 has a cover which includes opening side to cut bars.

### Easy to use

The CUTLAM®3.1 is extremely simple to operate with its large touch screen (5.7 inches) and intuitive interface. The 2 motorised axes of CUTLAM®3.1 (optional 3rd axis) can be controlled manually by two joysticks located near the control screen. The internal memory allow to save over 300 cutting programs, which can also be imported or exported via a USB port.

### A great variety of possible setting configuration

The rotation speed of the cutting wheel and the feed speed of the axes can be programmed so as to prevent any deterioration or deformation of the samples. 3 cutting modes are possible: manual (via joysticks), semi-automatic and automatic. The movements of the axes can be continuous or sequenced.

The CUTLAM®3.1 is also equipped with the smart motion function: the definition of an acceptable torque for the cutting wheel, with the touch screen will automatically regulate the feed speed of the axes.

This option makes it possible to cut materials with different hardnesses (e.g. steel with an HVOF coating) without having to modify the feed speed. This option allows to avoid long testing campaigns to define the correct feed speed.



## CUTLAM® 3.1

Automatic and programmable cutting machine with 2 or 3 motorised axes\*, equipped with a 300 mm  $\varnothing$  cut-off wheel

\*Optional motorised 3rd Axis (X)

### Theoretical cutting capacity - $\varnothing$ 300 mm

\*space under wheel

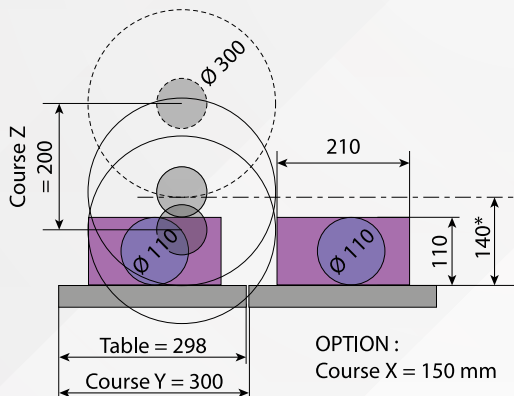

Height cut piece to be cut in mm

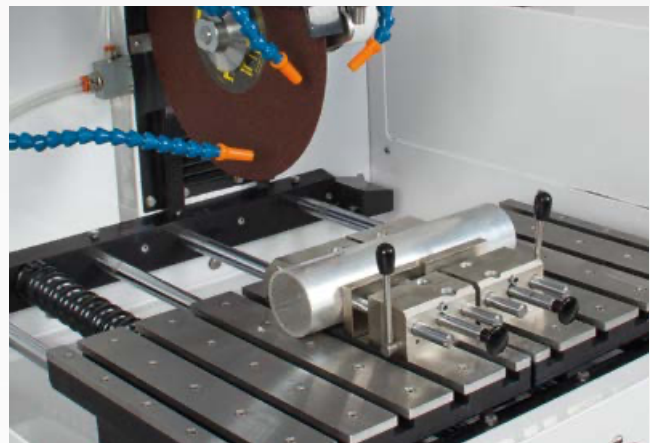
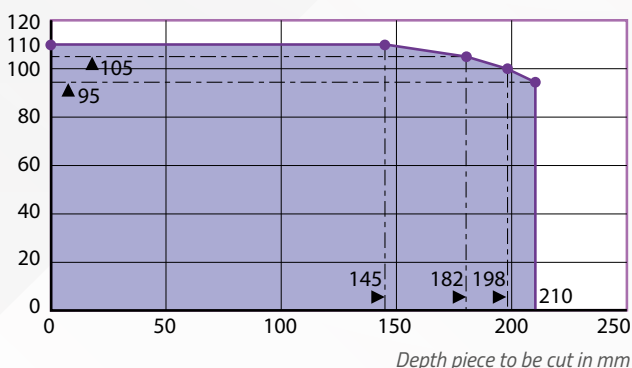

## CUTTING MACHINES

**Many cutting possibilities are offered**

This automatic cut-off machine makes it possible to cut vertically (along axis Z), over a maximum stroke of 200 mm, or to cut horizontally along axis Y, over a maximum stroke of 300 mm.

It is also possible to combine the two Z and Y movements. Thus, your machine will be able to perform cutting passes with a pass number and depth, which can be programmed.

This machine can optionally be equipped with a manual or automatic X axis for cutting parallel sections.

**Your safety, our priority**

An interlocking device maintains the cover in its closed position when the cutting wheel is rotating. When the cover is open, any axes movement (controlled by the joysticks) is only possible when the technician presses the "man present" button.

Technical Data	CUTLAM®3.1
Wheel Ø	250 to 305 mm
Shaft Ø	25,4 mm
Max cutting capacity	Ø 110 mm
Space between the cutting wheel and the table (with wheel Ø 300 mm)	140 mm
Table	Stainless steel 574 x 298 mm
Longitudinal movement - table	300 mm
Vertical movement - wheel	200 mm
Transversal movement	150 mm (optional)
Motor power wheel	3,8 kW
Cooling/Lubrication	Recirculation system, 60 litres decantation tank, 2 chambers, Input 100 µm filter, 800 L/hour pump driven by the machine
Wheel rotation speed	From 1000 to 4000 rpm
Cutting mode	Manual, semi-automatic, automatic
Feed speed control	From 0.1 to 20 mm/s, continuous or sequenced. Intelligent motion: automatic check of the feed motion according to the resulting torque on the cutting wheel motor
Lighting	LED strip
Protection	Cover secured by interlocking Man present button for operating the axes when the cover is open
Voltage	400 Volts - 50 Hz (three-phase + ground)
Dim. W x H x D	900 x 700 x 1000 (H. cover open 1100 mm)
Weight	210 kg
Reference	60CT30100



Support cabinet with integrated cooling system (60 litres).

**Options**

Manual X axis-table, stroke: 150 mm	60 CT31A20
Automatic X axis-table, stroke: 150 mm	60 CT31A30
Laser positioning device	60 CT31A10



60 CT31A30



60 CT31A20



60 CT31A10

**Accessories**

Double independent vice (left and right) with a screw-type tightening system	60 CT200 40
Double independent vice (left and right) with a fast tightening system	60 CT200 20
Cabinet for CUTLAM®3.1	60 M0310 00
Aspiration/filtration set (see specific page)	60 CT204 00



60 CT200 40



60 CT200 20



60 M0310 00



Quick positioning with joysticks. Touch screen with graphical interface.



Positioning laser.



## CUTLAM® 4.0

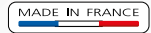

The CUTLAM®4.0 is designed especially for manufacturing companies with high standards who are looking for high-quality and reliable equipment for heavy-duty use with a great cutting capacity.

The CUTLAM®4.0 is a pedestal-mounted single-block machine with an integrated recirculation/decanter tank. The wheel's vertical descent can be controlled automatically (oleo pneumatic) or manually using the joystick. The maximum cutting descent is 240 mm.

Adapted for intensive use on heavy components, the CUTLAM®4.0 is fitted with a powerful 5.5 kW motor.

The wheel's speed is adjustable from 1000 to 4000 rpm, the feed speed is adjustable. 2 cutting modes are available: sequential automatic with adjustable frequency or continuous.

An end of cycle sensor shuts off the machine and automatically raises the wheel after each operation.

The controls are easy to use and intuitive: they are centralized on the 5.7" arm-mounted touch-screen.

The cover opening clears 3 sides, guaranteeing easy loading of heavy or bulky parts. Removable gates to the left and right enable you to cut long bars.

The wide cast-iron clamp bench has 6 T-longitudinal grooves and 5 transversal grooves, and as an optional extra may be made mobile along the X and the A axes.

The multi-point hose over the wheel and part ensures optimum cooling for high-quality cuts and consistent results.

In the standard configuration, the work area is illuminated by a adjustable spotlight, and an external shower head is provided for cleaning the cutting area.

In order to optimise your equipment according to your needs, a variety of accessories and optional extras are available.



**CUTLAM® 4.0**

**Thigh-capacity automatic cutting machine**

### Theoretical cutting capacity - Ø 400 mm

*\*space under wheel*

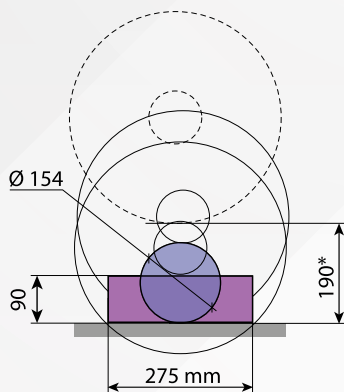



## CUTTING MACHINES



Transversal table X axis 120 mm stroke

Technical Data	CUTLAM® 4.0
Wheel Ø	300 to 400 mm
Shaft Ø	25,4 mm
Standard flanges Ø	100 mm
Max cutting capacity	Ø 154 mm or 145 x 160 mm or 90 x 275 mm (with a Ø 400 mm wheel) + right and left opening for long parts)
Passage under the wheel	190 mm (with a Ø 400 mm wheel)
Vertical movement	Manual
Lubrication	Recirculation system, 140 litres, on casters Cleaning system integrated, with a shower head outside of the cutting chamber
Motor power	5,5 kW
Rotational speed	Variable, from 1000 to 4000 rpm
Arm speed advance	5 to 200 mm/min during cutting
Table	Double grooved treated cast iron, 400 x 400 mm
Type of groove	T groove 12 mm (6 longitudinal, 5 transversal)
Lightening	LED
Protection	Cover with locking system
Body	Steel coated with epoxy paint
Pneumatic feeding compressed air	6 bars filtered 5 µ
Electrical power	6 kW cumulative
Electrical consumption	24 Ah
Voltage	400 Volts - 50 Hz (three-phase)
Dim. W x H x D	818 (+ 300 mm with control panel) x 1802 x 1280 mm
Weight	650 kg
Reference	60 CT40A 00



## Option

Positioning laser	60 CT403 00
-------------------	-------------



## Accessories

Universal clamping KOPAL 61	60 081282 20
Lift for KOPAL 61	60 081282 40
Long cam for KOPAL 61	60 00285 90
Independent double vice (right and left) with fast tightening system	60 CT400 20
Double vice with fast tightening system (left and right side of the wheel)	60 CT200 20
Double vice with screw tightening system (left and right side of the wheel)	60 CT200 40



60 081282 40



60 00285 90



60 081282 20



60 CT400 20



60 CT200 20



60 CT200 40

## Machine variations

Table with manual transversal displacement (X axis) of a 120 mm stroke	60 CT40A 10
Table with manual longitudinal displacement (Y axis) of a 180 mm stroke	60 CT40A 20



## CUTLAM<sup>5.0</sup>

High-capacity 2 or 3 axes programmable automatic cutting machine

### Theoretical cutting capacity - Ø 355 mm

*\*space under wheel*

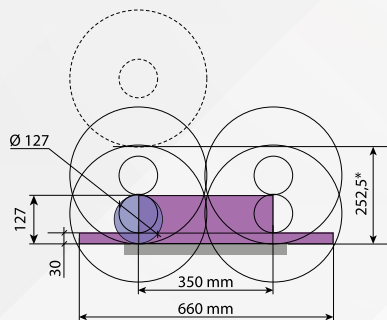

A spacious cutting chamber: W 408 x D 422 mm  
with openings on both right and left sides for the cutting of long samples.

## CUTLAM<sup>5.0</sup>

MADE IN FRANCE

The CUTLAM<sup>5.0</sup> is a pedestal-mounted machine with an integrated recirculation/decanter tank. It represents the ultimate equipment in terms of high-capacity programmable automatic cutting machines. Power and advanced control of the cutting steps will guarantee first class efficiency and productivity.

### Wheel and table movements

Fitted in standard with a Ø 355 mm wheel, which produces an automatic vertical and longitudinal movement. The automatic transverse movement is carried out by an optional cross-feed table.

### Controls

Programming is performed via a large touch screen with a graphical interface that ensures you an intuitive use. Cutting parameters are continuously visible on the screen. Fast positioning of the cutting point is provided by the use of a joystick.

The internal memory allows you to store 300 programs that can be transferred via USB.

### Easy programming

Depending on the location of the sample on the table, and on its dimensions, the screen will indicate the various necessary and possible moves in order to complete the cut. This data can then be saved.

### All cutting modes are possible

- Automatic or manual cutting.
- Continuous automatic cutting with ingenious feed speed control:

The feed speed is pre-set, and will be automatically reduced if the load on the cutting wheel increases. The pre-set speed returns when the load on the screen decreases.

It improves the quality of the cut by limiting the thermal damages over the samples.

It is suitable for irregular samples and/or material with heterogeneous hardness.

It prevents the wheel from breaking in case of overload.

It allows you to work at maximum speed without any risk of damage.

- Automatic sequential cutting for maximum cooling.
- Plunge cutting, horizontal feed cutting and oscillating cutting.
- Repetitive parallel cutting.



Work area lit  
by LED strip

## CUTTING MACHINES

## Equipments

A high-capacity, independent cooling/recirculation system (140 litres) is located under the machine. The multipoint nozzles insure excellent cooling of the sample and the cutting wheel even during intensive use.



Fast cleaning is made possible thanks to an exterior shower head and a carefully designed cutting chamber.

The wide cutting table: W 408 x D 422 mm is composed of two independent parts. 4 longitudinal grooves and 6 transversal grooves that allow to fix all kind of clamping systems available as options or on the market.

Technical Data	CUTLAM*5.0
Wheel Ø	355 mm (400 mm optional)
Shaft Ø	25,4 mm
Standard flanges Ø	100 mm
Max cutting capacity	Ø 127 mm (with Ø 355 mm wheel) + opening on left and right hand side for long parts
Passage under the wheel	252,5 mm (Ø 355 mm wheel)
Vertical movement	Z axis stroke 350 mm, speed from 0,1 to 25 mm/sec, speed advanced 50 mm/sec
Longitudinal movement	Y axis stroke 350 mm speed from 0,1 to 25 mm/sec advanced speed 50 mm/sec
Transversal movement	X axis stroke 120 mm (optional)
Lubrication	Recirculation system, 140 litres, on casters Cleaning system integrated, with a shower head outside of the cutting chamber
Motor power	5,5 kW
Rotational speed	Variable, from 1000 to 4000 rpm
Table	Treated aluminium and interchangeable stainless steel plate, W 408 x D 422 mm
Type of groove	T-slots 12 mm (4 longitudinal, 6 transversal)
Lightening	LED strip
Protection	Cover with locking system
Body	Steel coated with epoxy paint
Pneumatic feeding	6 bars filtered 5 µ
Electrical power	12 kW combined
Electrical consumption	32 Ah
Voltage	400 Volts - 50 Hz (three-phase + ground)
Dim. W x H x D	877 (+ 600 mm with control panel) x 1727 x 1800 mm (H. cover open 2272 mm)
Weight	750 kg
Reference	60 CT50A 00



## Options

Machine for cut-off wheel Ø 400 mm	60 CT503 00
Positioning laser	60 CT506 00



60 CT506 00



60 CT503 00

## Accessories

Universal clamping KOPAL 61	60 081282 20
Lift for KOPAL 61	60 081282 40
Long cam for KOPAL 61	60 00285 90
Independent double vice (right and left) with fast tightening system	60 CT400 20
Double vice with fast tightening system (left and right side of the wheel)	60 CT200 20
Double vice with screw tightening system (left and right side of the wheel)	60 CT200 40



60 081282 40



60 00285 90



60 081282 20



60 CT400 20



60 CT200 20



60 CT200 40

## Machine variations

Motorised cross-feed table (X axis) stroke 120 mm, accuracy 0,05 mm	60 CT50A 10
Motorised cross-feed table (X axis) stroke 380 mm, accuracy 0,05 mm	60 CT50A100

## Vices, clamping and accessories



Designation	Ref.	CUTLAM®Micro			CUTLAM®			
		1.1	2.0	3.0	1.1	3.1	4.0	5.0
Multi-screw sample holder for irregular parts	60 CTM03 50	✓	✓					
Screw vice holder: max Ø 12 mm	60 CTM03 30	✓	✓					
Screw V-shape sample holder: max Ø 24 mm	60 CTM03 20	✓	✓					
Screw double vice sample holder: Ø 12 mm maxi	60 CTM03 40	✓	✓					
Screw cylindrical sample holder: Ø 12 mm to 50 mm	60 CTM03 10	✓	✓					
Small vice with screw tightening system: Ø 12 mm	60 CTM02 10	✓	✓					
Medium vice with screw tightening system: Ø 24 mm	60 CTM02110		✓					
Double vice with fast tightening system (left and right side of the wheel) 2 x 2 elements vice, without sole, to obtain maximal length clamping Jaw width 80 mm Jaw height 45 mm T-slot 12 mm screw included Lever ( left and right )	60 CT200 20				✓	✓	✓	✓
Double vice with screw tightening system (left and right side of the wheel) 2 x 2 element vice, without sole, to obtain maximal length clamping Jaws width 80 mm, Jaws height 45 mm T-slot 12 mm screw included Left and right levers	60 CT200 40				✓	✓	✓	✓
Universal clamping KOPAL 61	60 081282 20				✓	✓	✓	✓
Lift for KOPAL 61	60 081282 40				✓	✓	✓	✓
Long cam for KOPAL 61	60 00285 90				✓	✓	✓	✓
Universal clamping KOPAL 54	60 CTM36 00			✓				

## ACCESSORIES FOR CUTTING MACHINES

Designation	Ref.	CUTLAM®Micro			CUTLAM®			
		1.1	2.0	3.0	1.1	3.1	4.0	5.0
Double vice with fast tightening system (left and right side of the wheel) 2 x 2 element vice, without sole, to obtain maximal length clamping Jaws width 80 mm Jaws height 70 mm T-slot 12 mm screw included Lever (left and right)	60 CT400 20						✓	✓
Transversal table (X movement) to perform parallel cuts. Manual movement with roller, stroke 100 mm, Display accuracy: 0,01 mm Can receive the right vice reference 60 CT200 20 or 60 CT200 40.	60 CT205 20				✓			
Double vice with fast tightening system for transversal table 60 CT205 20, right lever	60 CT206 20				✓			
Transversal table (X movement) manual movement with roller, stroke 150 mm, Display accuracy: 0,01 mm Can receive right vice reference 60 CT200 20 or 60 CT200 40	60 CT31A 20					✓		
Automatic transversal table (X movement), stroke 150 mm	60 CT31A 30					✓		
Specific vice with fast tightening system for transversal table 60 CT31A 20 and 60 CT31A 30, left lever	60 CT306 20					✓		
Transversal table (X movement) to execute parallel cuts. Manual movement with a roller, stroke 55 mm, precision 0,01 mm. Can receive right vice reference 60CT200 20 or 60 CT200 40.	60 CTM31 00			✓				
Automatic transversal table (X movement), stroke 50 mm, precision 0,01 mm	60 CTM34 00			✓				
Small right vice with fast tightening system stroke 53 mm	60 CTM32 00			✓				
Small left vice with fast tightening system stroke 53 mm	60 CTM33 00			✓				
Steel adaptor rings (by 5) Ø 22 x 12,7 mm	60 00608 90			✓				
PVC adaptor rings (by 5) Ø 22 x 12,7 mm	60 00609 90			✓				
Steel adaptor rings (by 5) Ø 25,4 x 12,7 mm	60 00369 90		✓	✓				
PVC adaptor rings (by 5) Ø 25,4 x 12,7 mm	60 00370 90		✓	✓				
Steel adaptor rings (by 5) Ø 25,4 x 22 mm	60 00372 90							
PVC adaptor rings (by 5) Ø 25,4 x 22 mm	60 00371 90							
Steel adaptor rings (by 5) Ø 32 x 25,4 mm	60 00373 90				✓	✓	✓	✓
PVC adaptor rings (by 5) Ø 32 x 25,4 mm	60 00374 90				✓	✓	✓	✓



## Oil mist extraction device

**NEW**

### A1

The LAM PLAN vacuuming system extracts the "polluted" air inside the cutting chamber of your cutting machine.

A special multilayer filter will stop the smallest polluting particles, thus preventing their dispersion into the atmosphere. The cutting fluid, in the liquid state, is returned to the cutting machine recirculation tank to be reused. (An evacuation is provided for this purpose on the vacuuming system).

A cartridge post-filter, located above the suction system, ensures a high filtration level, up to 99.97%.

An adapter part (LAM PLAN code 60CT20820) is provided to adapt the suction hose to the canopy of the LAM PLAN cutting machine.

The vacuuming system is mounted on a trolley with wheels, allowing an easy positioning.

A drain valve, located in the trolley, collects the condensate.



Technical features	Oil mist extraction device A1
Max flow air	245 m <sup>3</sup> /hour
Noise level	61 dBa
Rotation	2810 rpm
Height	1180 mm
Dimensions on floor	460 mm x 460 mm
Supplied with	2 meters of hose Ø 80 mm
Power supply	400V 3 phases - 50 Hz
Weight of the system	33 kg

Designation	Qty.	Ref.
A1	1	60 CT204 00



CUTLAM® 1.1



CUTLAM® 3.1



CUTLAM® 4.0



CUTLAM® 5.0

## ACCESSORIES FOR CUTTING MACHINES

## Filters

Characteristic	Qty.	Ref.
100 µm fabric filter for decantation tank CUTLAM Micro®2.0	1	60 00574 90
100 µm fabric filter for decantation tank CUTLAM®1.1 - 2.0 - 3.0 - Micro 3.0	1	60 00141 90
100 µm fabric filter for decantation tank CUTLAM®4.0 and 5.0	1	60 00576 90



## Refractometer

The refractometer is a measuring instrument which allows you to control the cutting fluid concentration in the machine to assure the quality of the cuts, to avoid the corrosion on the cut parts, the table and vices. It also controls heating during cuts (no smokes) and prevent from microbial and smells in the machine. The measured values are in BRIX degrees.

Designation	Qty.	Ref.
Refractometer	1	60 CT900 10



## Cutting fluid series 723

NEW

## Lubricating the cutting action

LAM PLAN cutting fluid 723 is a synthetic water-miscible coolant that has been approved for sectioning non-ferrous metals. This fluid provides excellent lubrication and optimal cooling so that the material's microstructures are not damaged during the cutting process. The cooling efficiency of cutting fluid 723 avoids overheating while lubricating the cutting action. It also has an optimum viscosity enabling it to flow freely.

Thanks to this fluid the cut parts and the materials will be protected from corrosion.

It does not lather. For an optimal use, we advise you to dilute 5 % of the solution in water or 3.6° BRIX to be measured with a refractometer. In order to maintain the efficiency of this fluid, we recommend you to check regularly its concentration with a refractometer.

Cutting fluid 723 is recommended for cutting titanium alloys and inconels. The properties of cutting fluid 723 also make it suitable for cutting non-ferrous alloys and carbides.

Properties	Type	Qty.	Ref.
Specialized cutting fluid : recommended for cutting titanium alloys and inconels.	723	5 litres	07 50723 50



## Cut-off wheels Serie H EXCELLENCE

**The new Excellence cut-off wheels offer faster cuttings without heating.**

These wheels can be used at high speed and assure an excellent quality without causing any damages on the material structure.

The quality of their function guarantees a greater life expectancy and limit the vibrations while cutting.

Available in three versions, the cut-off wheels H1, H2 and H4 will enable you to cut any metallic materials. In order to know what wheel is adequate to your need.



### EXCELLENCE H1 (AL<sub>2</sub>O<sub>3</sub>)

Type	Dim. (mm)	Qty.	Ref.
Soft/ semi-hard metals	250 x 32 x 1,5	10	05 83011 40
	300 x 32 x 2	10	05 83011 50
	350 x 32 x 2,5	10	05 83011 60
	400 x 32 x 3	10	05 83011 70



### EXCELLENCE H2 (AL<sub>2</sub>O<sub>3</sub>)

Type	Dim. (mm)	Qty.	Ref.
Treated metals/special metals	250 x 32 x 1,5	10	05 83021 40
	300 x 32 x 2	10	05 83021 50
	350 x 32 x 2,5	10	05 83021 60
	400 x 32 x 3	10	05 83021 70



### EXCELLENCE H3 (AL<sub>2</sub>O<sub>3</sub>)

**NEW**

Type	Dim. (mm)	Qty.	Ref.
Inconel	250 x 32 x 1,5	10	05 84041 40
	300 x 32 x 2	10	05 84041 50
	350 x 32 x 2,5	10	05 84041 60
	400 x 32 x 3	10	05 84041 70



## CUT-OFF WHEELS

## EXCELLENCE H4 (SIC)

Type	Dim. (mm)	Qty.	Ref.
	250 x 32 x 1,5	10	05 85041 40
Non ferrous materials	300 x 32 x 2	10	05 85041 50
Casting	350 x 32 x 2,5	10	05 85041 60
	400 x 32 x 3	10	05 85041 70

-12% for a quantity of  $\geq 50$  wheels of the same reference

Please contact us for a diameter superior to 400 mm.



## SERIE H EXCELLENCE

The chart below indicates the adequate wheels to choose according to the different materials to be cut.

GUIDANCE

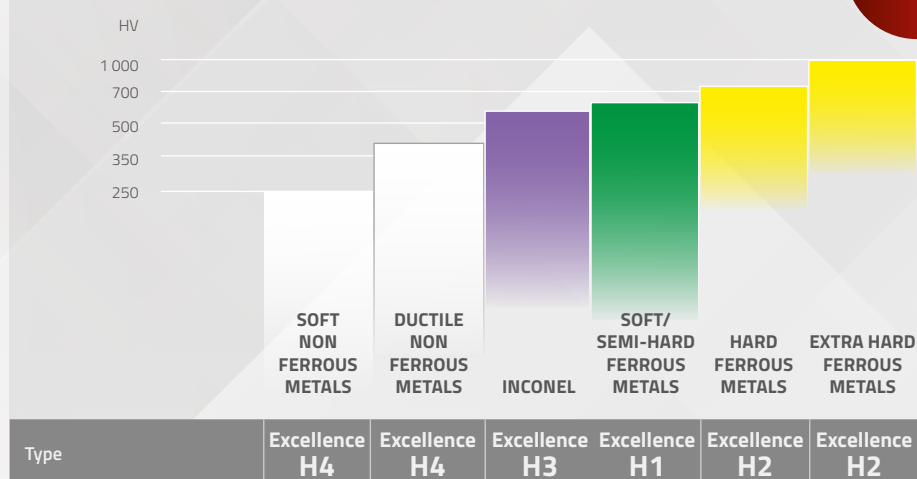

## Adaptor rings

Designation	Ø mm	Qty.	Ref.
Adaptor ring - PVC For cut-off wheels	22 / 12,7	5	60 00609 90
	25,4 / 12,7	5	60 00370 90
	25,4 / 22	5	60 00372 90
	32 / 25,4	5	60 00374 90
Adaptor ring - Steel For cut-off wheels	22 / 12,7	5	60 00608 90
	25,4 / 12,7	5	60 00369 90
	25,4 / 22	5	60 00371 90
	32 / 25,4	5	60 00373 90



## Cut-off wheels PRECISION

### Combine performance and versatility

Elaborated according to a very rigorous specification, these cut-off wheels offer the user a precision cutting thanks to the characteristics of its binder and the quality of its abrasives.

Usable on all cutting machines, these wheels give cut-off quality which allows reducing the duration of the downstream operations.

LAM PLAN precision cut-off wheels are available in 6 versions according to their hardness and the abrasive used in their composition. The visual colour code facilitates memory.



### RED (AL<sub>2</sub>O<sub>3</sub>)

Type	Dim. (mm)	Qty.	Ref.
Soft – semi-hard steel	125 x 12,7 x 0,45	5	05 80016 90
	150 x 12,7 x 0,45	5	05 80016 10



### T1 (AL<sub>2</sub>O<sub>3</sub>)

Type	Dim. (mm)	Qty.	Ref.
Soft – semi-hard steel	200 x 25,4 x 0,8	10	05 911P02000
	250 x 32 x 1,2	10	05 911P42500
	300 x 32 x 1,5	10	05 911P43000

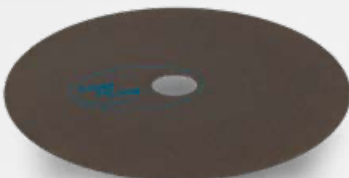

### BLUE (AL<sub>2</sub>O<sub>3</sub>)

Type	Dim. (mm)	Qty.	Ref.
Treated metals- special steel	125 X 12,7 X 0,45	5	05 80013 90
	150 x 12,7 x 0,45	5	05 80013 10
	203 x 25,4 x 1	10	05 80013 20



### T2 (AL<sub>2</sub>O<sub>3</sub>)

Type	Dim. (mm)	Qty.	Ref.
Treated metals- special steel	250 x 32 x 1,2	10	05 921P42500
	300 x 32 x 1,5	10	05 921P43000



### WHITE (SiC)

Type	Dim. (mm)	Qty.	Ref.
Non ductile material Cast iron Stainless steel	125 x 12,7 x 0,45	5	05 80025 90
	150 x 12,7 x 0,45	5	05 80025 10
	203 x 25,4 x 1	10	05 80025 20
	250 x 32 x 1,5	10	05 80025 40
	305 x 32 x 1,5	10	05 80025 50

## CUT-OFF WHEELS

## Cut-off wheels PRECISION DIAMANT

Type	Dim. (mm)	Qty.	Ref.
	101,6 x 12,7 x 0,30	1	05 82129 10
All sintered materials	125 x 12,7 x 0,38	1	05 82129 20
Ceramic			
Cermet	152 x 12,7 x 0,5	1	05 82129 30
Carbide W and Sic	203 x 32 x 0,8	1	05 82130 30
Glass, silica, quartz	254 x 32 x 1	1	05 82335 40
High metal content materials	305 x 32 x 1,3	1	05 82335 50



## Cut-off wheels PRECISION CBN

Type	Dim. (mm)	Qty.	Ref.
Heterogeneous hardness materials ex. : carbide coating on, steel substrate	152 x 12,7 x 0,38	1	05 82129130

-12% for a quantity of  $\geq 50$  wheels of the same reference

## PRECISION

The table below will help you determine the right cut-off wheel choice for the material to be cut.

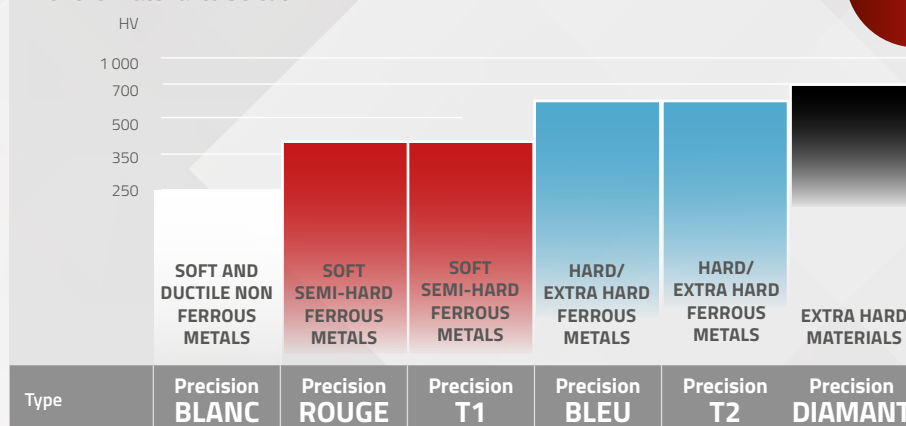

GUIDANCE

## Adaptor rings

Type	Dim. (mm)	Qty.	Ref.
	22 / 12,7	5	60 00609 90
Adaptor ring - PVC	25,4 / 12,7	5	60 00370 90
For cut-off wheels	25,4 / 22	5	60 00372 90
	32 / 25,4	5	60 00374 90
Adaptor ring - Steel	22 / 12,7	5	60 00608 90
For cut-off wheels	25,4 / 12,7	5	60 00369 90
	25,4 / 22	5	60 00371 90
	32 / 25,4	5	60 00373 90



# MOUNTING



MOUNTING MACHINES

## PRESSLAM® 1.1

MADE IN FRANCE

The PRESSLAM® 1.1 is a multi-purpose, easy-to-use, automatic hot mounting press that will allow you to achieve high production levels. All parameters are accessible via a 5.7" colour touch screen. The graphic interface guides you intuitively through the different settings, which you can then store and reuse at will. It is also possible to transfer predefined hot mounting parameters via the machine's USB port. All phases are visible on the screen during the hot mounting cycle and can be modified at any time.

Each function can be adjusted separately and 4 pressurisation modes are available, along with a function reducing the amount of water used for cooling.



**PRESSLAM® 1.1**

Easy-to-use, productive,  
automatic hot mounting press



Technical Data	PRESSLAM® 1.1
Capacity	Ø 25,4 to Ø 50 mm
Heating system	4 x 600 W around mould
Temperature range	20 to 200 °C
Heating cycle	0 to 30 min
Cooling cycle	0 to 30 min
Pressure	0 to 1,600 daN
Double mounting	yes – all diameters
Program back-up	300 with USB connexion
Pressurisation modes	4 different modes
Chamber closing	half turned cover with a safety chamber
Mould changing	Quick, without connectors- electric or hydraulic
Pre-heating mode	Yes (cleared after 6 min without manipulation)
Water saving	yes (up to 25%)
Voltage	230 V – 50 Hz single-phase
Pneumatic feed	6 to 10 bars
Dimensions W x H x D	250 x 680 x 470 mm
Weight	72 kg (depending on mould size)
Reference	60 PL110 00

Once put in service the PRESSLAM® 1.1 runs a pre-heating cycle that is cleared after 6 minutes without user intervention.

Access to mould is wide open for a sample positioning and filling facility. Quick and effortless, the locking/unlocking is realised by a cover and a ¼ turn locking lever.

### Exclusive safety device

The expulsion of the sample after the mounting cycle is only possible when the safety cover is located in its intermediary position. This device creates a safety chamber in which the sample is protected in case of an eventual sticking situation.



Closed

Safe position  
for sample recovery

Open

Embedding allows limiting edge stresses during the polishing step.

This operation will also allow you:

- In manual polishing: to facilitate the holding of the sample
- In automatic polishing: to place several samples together in a sample holder under optimum tightening conditions

## MOUNTING MACHINES

The PRESSLAM®1.1 is equipped with a main heating unit which contains the removable cylinder. The standard heating unit covers diameters from 25,4 to 40 mm and a specific element is available for a 50 mm diameter.

**The mounting chamber can be changed without any tools, nor electric or hydraulic connections.**

It only takes a few minutes to change the complete heating unit.

The PRESSLAM®1.1 is the ideal link in your mounted sample production line. It is a compact machine that is both easy to use and easy to maintain and will allow you to increase your productivity while maintaining unrivalled flexibility.



Heating unit for mould assembly Ø 25,4 mm (1"), 30 mm, 40 mm, 1 1/4" and 1 1/2", 50 mm and 2"



Independent cooling unit to use the PRESSLAM®1.1 without water supply



Spacer for double mounting

## Accessories

Heating unit for Ø 25.4 mm (1"), 30, 40 mm, 1 1/4" and 1 1/2"	60 PL2H1 00
Heating unit for Ø 50 mm and 2"	60 PL2H2 00
Assembly mould Ø 25,4 mm or 1"	60 PL1C1 00
Assembly mould Ø 30 mm	60 PL1C2 00
Assembly mould Ø 40 mm	60 PL1C4 00
Assembly mould Ø 50 mm	60 PL1C5 00
Assembly mould Ø 1 1/4"	60 PL1C2 10
Assembly mould Ø 1 1/2"	60 PL1C4 10
Assembly mould Ø 2"	60 PL1C5 10
Spacer Ø 25,4 mm or 1" for double mounting	60 PL2I1 10
Spacer Ø 30 mm for double mounting	60 PL2I2 00
Spacer Ø 40 mm for double mounting	60 PL2I4 00
Spacer Ø 50 mm for double mounting	60 PL2I5 00
Spacer Ø 1 1/4" for double mounting	60 PL2I2 10
Spacer Ø 1 1/2" for double mounting	60 PL2I4 10
Spacer Ø 2" for double mounting	60 PL2I5 10
Compressed air filtration kit	60 00375 90
Cooling unit	60 PL090 00

## Parameters recapitulation PRESSLAM®1.1 with LAM PLAN hot mounting resins.

Resine	Heating time (min)				Cooling time (min)				Pressure (daN)				Temperature (°C)				Pressure mode
	Ø 25	Ø 30	Ø 40	Ø 50	Ø 25	Ø 30	Ø 40	Ø 50	Ø 25	Ø 30	Ø 40	Ø 50	Ø 25	Ø 30	Ø 40	Ø 50	
Phenolic (602, 622, 632, 642)	3.5	3.5	4	5,5	3	3	3	3.5	800	1000	1200	1400	170	170	170	170	
Epoxy (633, 634) Use the SOLILUB	4	5	5	6.5	4	4	4	4.5	800	1000	1200	1400	180	180	180	180	
Acrylic (616, 2 and 616)	4.5	5	5.5	6.5	4	4	4	4.5	800	1000	1200	1400	170	170	170	170	
Copper (604.3)	3	3	3,5	5,5	3	3	3	3.5	800	1000	1200	1400	170	170	170	170	
Phenofree Use the SOLILUB	3	3	4	5.5	3	3	3,5	3.5	1000	1000	1200	1400	175	175	175	175	
Graphite (617)	3	3	3.5	4.5	3	3	3	3.5	800	1000	1200	1400	170	170	170	170	

GUIDANCE



## M.M.808

NEW

MADE IN FRANCE

**M.M.808 creates a pressurized environment for polymerization to avoid bubbles in the mount without affecting the physical characteristics of the resin.**

While M.M.808 can be used with all cold mounting resins, it is highly recommended to be used with transparent EPOXY RESINS 603 / 603.2 and ACRYLIC RESIN 609.

### Avantage

By avoiding entrapped bubbles in transparent mounts, the visibility of the sample can be improved.

In all cold mounting resins, avoiding bubbles improve edge retention while grinding and polishing metallographic samples.

By avoiding entrapment of abrasives in bubbles, M.M.808 helps improve the polishing quality after mounting.

Additionally, using the M.M.808 unit for cold mounting eliminates the odors typical of cold mounting resins.



## M.M. 808

For cold mounting metallographic samples under pressure



Technical Data	M.M.808
Pressure connection	3 to 10 bar
Nominal pressure	2 bar
Max. operating pressure	2,8 bar
Dimensions W x H x D	300 x 305 x 400 mm
Weight	8,6 kg
Inner diameter of lid opening	210 mm
Inner diameter base	225 mm
Pressure pot height to cover edge	190 mm
Reference	08 00808 20



## M.M.818

NEW

Compact vacuum mounting unit for impregnation of porous materials and bubble-free mounting with epoxy resins type 603. The M.M.818 has a large capacity vacuum chamber of 160 mm diameter and is equipped with a resin distribution system. A vacuum gauge on the front panel allows the vacuum level to be monitored and the various vacuum cycles to be controlled manually.

Technical Data	M.M.818
Vacuum level	- 650 mm-Hg
Inner diameter base	160 mm
Useful height of vacuum tank	160 mm
Dimensions W x H x D	480 x 400 x 400 mm
Vacuum pump dimensions (W x H x D)	140 x 210 x 240 mm
Power supply	230 V - 50 Hz single phase
Weight	10,10 kg
Weight vacuum pump	7,25 kg
Reference	08 00818 00

## M.M. 818

Vacuum impregnation device

## HOT MOUNTING RESINS

## PHENOFREE hot moulding resin

### New phenol-free and formaldehyde-free thermosetting mounting resin

In line with its ecological commitment, LAM PLAN proposes on the market the first effective alternative to phenol metallographic mounting resins which are liable to release phenol (and/or formaldehyde) during baking.

The PHENOFREE mounting is intended for the technical mounting of all types of materials for material examinations or edge examinations. It smartly replaces the traditional phenol mounting resins with the same hardness and less shrinkage than a phenol mounting resins.

The range of PHENOFREE resins includes 3 coloured resins (grey, white and red) to make the identification of your metallographic samples easier. They are particularly adapted for the polishing of hard materials. The white Phenofree resin may prove to be in some cases a good alternative to the use of epoxy resins.

Characteristics	Qty. in kg	Ref.
<b>PHENOFREE 1</b>		
Grey composite powder Polyvalent, hard	2,5	06 PF010 20
	10	06 PF010 10
	25	06 PF010 50
<b>PHENOFREE 2</b>		
Red composite powder Polyvalent, very hard	2,5	06 PF020 20
	10	06 PF020 10
	25	06 PF020 50
<b>PHENOFREE 3</b>		
White composite powder Polyvalent, extra hard	2,5	06 PF030 20
	10	06 PF030 10
	25	06 PF030 50

Require the unmoulding agent SOLILUB.

## Unmoulding agent

Recommended for PHENOFREE, 633 and 634 resins.

### SOLILUB

Characteristics	Qty.	Ref.
Anti-stick powder for hot mounting process	Pot de 50 g	06 00683 00



Phenol-free  
Formaldehyde-free



## Hot mounting resins

To respond to all metallographic control and research situations, LAM PLAN developed and tested a range of hot mounting resins. Each resin is characterised by a very specific physical and chemical properties.

### EPOXY RESINS 633 AND 634

The black epoxy mounting resin is filled with glass fibres with high mineral loads. It is ideal for mountings intended for edge examinations of hard to extra hard materials thanks to its resistance to abrasion, important hardness and absence of shrinkage. The 634 is a fine powder epoxy resin, used for examination of edged samples.

Characteristics	Qty.	Ref.
<b>633</b>		
Black epoxy powder, loaded with glass fibres	2,5 kg	06 00633 20
Edges examinations		
Extra hardness - No shrinkage	10 kg	06 00633 10
<b>634</b>		
Black epoxy powder, fine grains	2,5 kg	06 00634 20
Edge examinations on complex samples		
High hardness - No shrinkage		

### ACRYLIC RESINS 616 AND 616.2

The acrylic resin 616 is perfectly transparent and adapted to most materials. Mainly used to view the evolution of the grinding of the sample.

Perfectly transparent with no cotton effect, the acrylic resin 616.2 is resistant to alcohol, and therefore ideal for work with alcohol-based polishing products or requiring a cleaning phase with ethanol, isopropyl alcohol or other.

Characteristics	Qty.	Ref.
<b>616</b>		
Transparent acrylic powder.	2,5 kg	06 00616 20
Visualising the sample during and after the polishing. All materials.	10 kg	06 00616 10
<b>616.2</b>		
Transparent acrylic powder.	2,5 kg	06 06162 20
Visualising the sample during and after the polishing. Alcohol resistant.	10 kg	06 06162 10

### COPPER MOUNTING RESIN 604.3

Conductive mounting resin for examinations with SEM or electrolytic etching device. A pure copper based resin of very homogeneous consistency, the conductivity of your mountings is optimised. The use of ultra-pure materials eliminates the risk of an analysis error.

Characteristics	Qty.	Ref.
Resinoid copper powder	2 kg	06 00604 30
For electrolytic polishing.		





## HOT MOUNTING RESINS

## GRAPHITE MOUNTING RESIN 617

Conductive phenolic mounting resin loaded with graphite (without copper and without metals or alloys) for SEM and TEM examinations.



GUIDANCE

Characteristics	Qty.	Ref.
Conductive black phenolic powder (graphite) For SEM examination	1,5 kg	06 00617 00













## Advice on the use of LAM PLAN hot mounting resins

Material	Resin	Characteristics	Volumetric shrinkage	Color	Polymerisation time*
Composite	PHENOFREE 1 PHENOFREE 2 PHENOFREE 3	Phenol & formaldehyde Free	Low	Grey Red White	10 to 15 min
Epoxy	633	Extra hard	Very low	Black	5 to 10 min
Epoxy	634	Extra hard (fine grain)	Very low	Black	5 to 10 min
Acrylic	616	Excellent transparency	Low	Transparent	5 to 10 min
Acrylic	616.2	Transparent and alcohol resist	Low	Transparent	5 to 10 min
Copper	604.3	High conductivity	Low	Coppered	10 min
Graphite	617	Conductable	Low	Black	5 to 10 min

\* Depending of the machines' characteristics

## Diagnosis and guidance for hot mounting resins

Before to begin any mounting process, the grease needs to be removed from the samples in order for the resin to adhere to the contours of the parts. Check if any burrs were committed in the cutting process. If necessary, deburr the sample's edges with an abrasive paper.

Noticed faults	Cause	Solution
Primer cracks on the sample's edges	 Oversized Coated part according to the chosen mounting mould	Reduce the size of the sample or increase the size of the mounting mould
Shrinkage	 Inadequate mounting resins	Choose a resin offering less shrinkage
	 Insufficient heating time	Increase the temperature during the heating time
	 Inadequate pressure mode and insufficient pressure	- Use the machine mode adjusting the temperature curve - Increase the mounting pressure
Resins grains visible on the faces of the sample	 Insufficient pressure	Increase the pressure during the mounting cycle
	 Insufficient heating time	Increase the heating time
"Smoke" visible in a transparent mounting	 Wrong pressure choice	Choose a pressurisation only during the cooling cycle
	 Too much resin according to the size of the sample	Limit the quantity of resin inserted in the mould or reduce the size of the mould
Mounting stuck in the mould	 Insufficient heating time	Increase the heating time
	 Insufficient "solilub" powder	Drop a sufficient amount of "solilub" on the machine's superior and inferior pistons
Bulge on top of the mounting	 Insufficient heating time	Increase the heating time
	 Insufficient cooling time	Increase the cooling time

## Cold mounting resins

Mainly intended for the metallography research sector, the LAM PLAN range of cold mounting resins offers many technical and economic advantages.

The cold mounting resins are the solution for samples which do not withstand high pressure or temperature. In addition, they allow responding in a simple and efficient way to timely needs by circumventing the investment of a hot mounting press. You can achieve a large quantity of samples simultaneously while adjusting precisely the volume of mounting material and shape of the moulds.

### ACRYLIC RESIN 601.2



The fluidity of this transparent mounting resin and its very low shrinkage ensure a maximum penetration ratio in cavities. It is ideal for microelectronics, optics and microsystem applications. Compatible for conventional scanning electron microscopy (SEM) examinations.

Mono-component resin easy to dose and manipulate (no loss). Polymerisation with low temperature rise in 20 minutes in the blue light device M.M.866 + 10 minutes for the surface varnish. With no disturbing odour, it is resistant to alcohol and acids..

Characteristics	Qty.	Ref.
Transparent Acrylic Monocomponent	Resin 1000 ml + varnish 100 ml set	06 00601 00
Maximum exothermic temperature: 95°	Resin 1000 ml	06 01601 00
	Varnish 100 ml	06 01602 00



Without shrinkage

### EPOXY RESIN 603

The Resin 603 is a two-component epoxy resin without CMR substance used to achieve high quality technical metallographic mountings at room temperature. This resin is the best choice when the transparency of the coating is a requirement. The resin has zero shrinkage, excellent adhesion to all kinds of materials and a very good chemical resistance.

With an ideally adjusted viscosity, the resin 603 is used to mount metallographic specimens with complex shapes, porosities, or delicate technical coatings.

Characteristics	Qty.	Ref.
Transparent Epoxy 2 liquid components	Liquid 1000 ml + hardener 500 ml set	06 00603 00
Maximum exothermic temperature: 105°	Liquid 1000 ml	06 01603 00
	Hardener 500 ml	06 02603 00

### EPOXY RESIN 603.2

The Resin 603.2 is a fast-curing two-component epoxy resin without CMR substance used to make technical metallographic mountings. It must be used on materials that withstand temperatures of 140°C.

This transparent resin has zero shrinkage, excellent adhesion to all kinds of materials and very good chemical resistance.



Fast hardening

Characteristics	Qty.	Ref.
Transparent Epoxy 2 liquid components	Liquid 1000 ml + hardener 500 ml set	06 00603 20
Maximum exothermic temperature: 140°	Liquid 1000 ml	06 01603 20
	Hardener 500 ml	06 02603 20

## COLD MOUNTING RESINS

**METHYL-METHACRYLATE RESIN 605**

Versatile, it is adapted to the majority of common materials for the fast mounting standard sample. It is possible to change the viscosity by modifying the proportion of the mixture: liquid + powder. Resistant to the principal acids used in laboratories.

**Solvent free and CMR-free** (no Carcinogenic, Mutagenic, toxic to Reproduction susceptences).

Characteristics	Qty.	Ref.
Green Methyl-methacrylate 2 components (powder and liquid)	Powder 1 kg + catalyst 500 ml set	06 00605 00
	Catalyst 500 ml	06 00615 00
Maximum exothermic temperature: 108°	Powder kit (10 kg) + catalyst (5 litres)	06 00605 10
	Catalyst (5 litres: pack. 2 x 2.5 litres)*	06 00615 10

**POLYESTER RESIN 607**

The Resin 607 is a three-component resin based on modified polyester.

This fast curing resin adheres perfectly to metal surfaces and its mechanical characteristics make it particularly effective on very hard materials.

Its very low shrinkage allows edge examinations on metallographic samples. It is resistant to the main acids and bases used in laboratories.

Characteristics	Qty.	Ref.
Modified white polyester 3 components	Resin kit: catalyst 500 ml + hardener 250 ml + powder 750 g	06 00607 00
	Catalyst 500 ml	06 00607 10
Maximum exothermic temperature: 122°	Hardener 250 ml	06 00607 20
	Powder 750 g	06 00607 30

**METHYL-METHACRYLATE RESIN 609**

A perfectly transparent resin used for precision parts, notably those of the electrical or electronics industry. It renders the sample perfectly visible, which allows analysing precise points. It must be used with the pneumatic device M.M.808 to obtain an optimum transparency.

The methyl-methacrylate resin 609 is available in the Plastichrome version – 5 transparent colours to simplify the classification of samples.

**Solvent free and CMR-free** (no Carcinogenic, Mutagenic, toxic to Reproduction susceptences).

**609**

Characteristics	Qty.	Ref.
Methyl-methacrylate Transparent	Powder 1 kg + catalyst 500 ml set	06 00609 00
	Catalyst 500 ml	06 00619 00
2 components (powder + liquid)	Powder 1 kg	06 00609 20
	Powder 10 kg + catalyst 5000 ml set	06 00609 10
Maximum exothermic temperature: 99°	Catalyst 5000 ml (pack. 2 x 2500 ml)*	06 00619 10

**609 PLASTICHROME**

Characteristics	Qty.	Color	Ref.
Methyl-methacrylate Transparent coloured 2 components (powder + liquid) Maximum exothermic temperature: 99°	Powder 1 kg + Catalyst 500 ml set	BLUE	06 0071B 00
		YELLOW	06 0071J 00
		ORANGE	06 0071O 00
		RED	06 0071R 00
		GREEN	06 0071V 00

\* Packaging related to transport restrictions



CMR-free



NEW

**METHYL-METHACRYLATE RESIN 665**

**Cold setting resin for sample recovery.**

Mounting is a step in metallographic sample preparation which enables samples to be ground and polished more ergonomically. Embedding the sample in a resin is usually irreversible and recovering the sample (if necessary) after embedding proves almost impossible.

Resin 665 is a cold mounting resin that has the unique ability to dissolve in acetone. This ability is transformed into a sustainable functionality to recover metallographic specimens after mounting. After metallographic processing of costly materials such as noble metals, it is often important from an economic and technical perspective to recover the samples from the mounting resin.

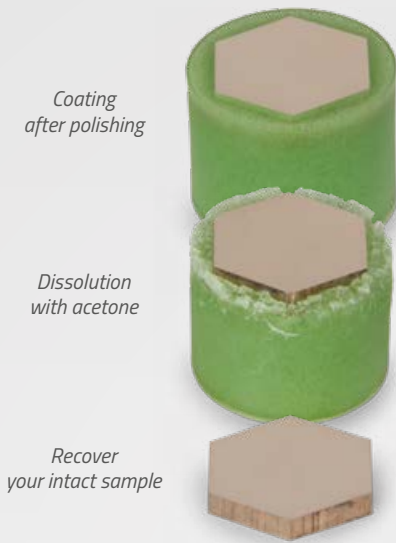

Characteristics	Qty.	Ref.
Modified green polyester 2 components (Powder + Liquid)	Powder 1 kg + catalyst 500 ml set	06 00665 00
Maximum exothermic temperature: 112°	Catalyst 500 ml	06 02665 00
	Powder 1 kg	06 01665 00

**Advice on the use of LAM PLAN cold resins**

Material	Resin	Characteristics	Volumetrical shrinkage	T°*	Color	Polymerisation
Acrylic	601.2	Liquid monocomponent Low heating	Very low	95°C	Transparent	Curing < 20 min in the blue lightening device +10 min for the varnish
Epoxy	603	Without shrinkage	Non-existent if used with pressure device M.M.808	105°C	Transparent	Curing 10 hours
	603.2	Fast curing excellent adhesion	Non-existent	140°C	Transparent	Curing 2 hours
Methyl methacrylate	605	Versatility	1 %	108°C	Green	Fast Curing < 10 min
Modified polyester	607	Hardness	Very Low (<0,2%)	122°C	Beige	Fast Curing < 15 min
Methyl methacrylate	609	Excellent transparency if used with pressure device M.M.808	1 %	99°C	Transparent = colourless + 5 colours (series Plastichrome )	Fast Curing < 10 min
Methyl methacrylate	665	Soluble resin	Correct	112°C	Green	Fast Curing < 15 min

\* Peak exothermic temperatures during polymerisation for a 40 g sample of resin at 20°C

GUIDANCE

**Procedure for cold mounting**

Keep the thin samples on the slice. Mix the resin components in the indicated proportions. Mix gently to avoid creating air bubbles. Pour the resin into the mould to the desired level and allow to cure in the open air or in an M.M.808 pressure vessel to remove any bubbles or pores. To limit heating and shrinkage, fill the mould in successive layers.

Resin	Blending proportions
601.2	1 liquid + 1 varnish. Apply the varnish on top of the coating 20 minutes after polymerisation in the M.M.866 device
603	2 volums of powder for 1 volume of liquid
603.2	2 volums of powder for 1 volume of liquid
605	2 volums of powder for 2 volums of liquid 1 and 1 volume of liquid 2
607	3 volums of powder for 2 volume of liquid
609	2 volums of powder for 1 volume of liquid
665	2 volums of powder for 1 volume of liquid

GUIDANCE

## ACCESSORIES

## Polymerisation lamp M.M.866

The blue light polymerisation device enables you to speed up the polymerisation process of the 601.2 resin. (20 minutes)

Designation	Characteristics	Ref.
Blue light mounting device	Solar energy collector for light-curing resins. Equipped with a timer (3 positions): 5 min. 10 min. and continual.	08 00866 10



## ISOFORCE

NEW

The ISOFORCE device allows flattening of embedded samples in a central pressure sample holder. Homogeneous pressure is applied to each sample via a pneumatic cylinder. The operation is carried out in complete safety thanks to the dual control system.

Designation	Characteristics	Ref.
ISOFORCE	Ø 210 mm	60 MLISI 210
	Ø 160 mm	60 MLISI 160



## Moulds with removal bottom

Mainly used with the transparent mounting resins (601.2, 609, 603 & 603.2).

Type	Qty.	Dim. (mm)	Ref.
681	5	25	06 00681 10
	5	30	06 00681 20
	5	32	06 00681 30
	5	40	06 00681 40



## Flexible rectangular cold mounting moulds

Specifically, for cold mounting resin, adapted to complex and nonstandard shapes, many dimensions available, made of a flexible material to facilitate mould removal (Not recommended for EPOXY resins).

Type	Qty.	Dim. (mm)	Ref.
Flexible 670	5	70 x 30 x 40	06 00670 10
	5	100 x 42 x 30	06 00670 20
	5	120 x 50 x 30	06 00670 30
	5	100 x 70 x 30	06 00670 40
Flexible 670 4 pieces set	1	70 x 30 x 40	06 00670 00
	1	100 x 42 x 30	
	1	120 x 50 x 30	
	1	100 x 70 x 30	

Any other dimensions on request.





## Flexible cylindrical cold mounting moulds

Available in all standard diameters for central and individual pressure sample holders, made of a flexible material to facilitate mould removal.  
(For an intensive use of the EPOXY 603 resin, it is preferable to use moulds with removable bottoms).

Type	Qty.	Dim. (mm)	Ref.
Flexible 625	5	Ø 25	06 00625 00
Flexible 630	5	Ø 30	06 00630 00
Flexible 632	5	Ø 32	06 00632 00
Flexible 640	5	Ø 40	06 00640 00
Flexible 650	5	Ø 50	06 00650 00
Flexible 660	5	Ø 60	06 00660 00



## Universal sample-holder mould Series 610

The LAM PLAN universal sample-holder is a smart and economical system which combines the functions of both mould and sample-holder for cold mounting processes using any kind of cold liquid resin.

See details page **ACCESSORIES FOR POLISHING MACHINES**.



## Cups and spatulas

Paper cups and wooden spatulas to mix cold mounting resins.

Characteristics	Qty.	Capacity	Ref.
Paper cups	200	200 ml	06 00696 00
Set: cups and spatulas	400 cups 400 spatulas		06 00698 00

## Micro engraver

To mark and identify samples.

### M.M.886

Characteristics	Ref.
Speed 0-20 000 rpm Clamping jaw: Ø 1,58 mm - Ø 2,35 mm - Ø 3,175 mm	10 88630 00



## ACCESSORIES

## Charge element for resin

The Voluma spheres are ceramic balls used as sole or base. They allow increasing the hardness of the mounting resins and decrease their shrinkage in order to reduce fallen edge effects. They are adapted to all types of hot and cold mounting resins; available in various colours to personalize samples..

### VOLUMA SPHERES

Characteristics	Qty.	Ref.
3-colour set	3 bottles of 250 cc	06 0075V 00
Blue	250 cc	06 0075V 20
Ivory	250 cc	06 0075V 30
Red	250 cc	06 0075V 10



## Dye

### EPOCHROME POWDER

NEW

Fluorescent contrast dye to be mixed with clear mounting resins, highlights porosity and micro-cracks. Requires the use of filters on the microscope for optimal results. The wavelength at maximum absorbance is 438-440 nm.

Mainly used with LAM PLAN 603 and 603.2 epoxy resins.

Characteristics	Qty.	Ref.
EPOCHROME powder dye	20 g pot	06 0EPCH 00



## Unmoulding agent

### SOLILUB

Recommended for PHENOFREE, 633 and 634 resins.

Characteristics	Qty.	Ref.
Anti-stick powder for hot mounting process	50 g pot	06 00683 00



## Blade-holders

For the vertical positioning of thin sections, to use of cold mounting resin.

Type	Qty.	Thickness in mm	Ref.
Blade-holder series 690	100	1	06 00690 10
Blade-holder series 691	100	2	06 00690 20
Blade-holder series 692	100	3	06 00690 30

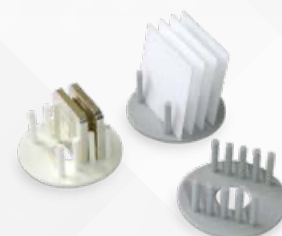

## Holding clips

Characteristics	Qty.	Ref.
-----------------	------	------

### CLIPS TYPE 3

Holding plastic, raised clips to use with cold mounting resin.

100 06 00694 00

### CLIPS TYPE 5

Holding clips type 5 metal clips to use with hot mounting resin.

100 06 00693 00



# PREPOLISHING & POLISHING

PREPOLISHING MACHINE



## RECTILAM® 2.0

MADE IN FRANCE

When the prepolishing phase demands a high level of effectiveness and precision the RECTILAM® 2.0 is the answer. This machine is particularly productive in the preparation of coated or raw samples by high speed prepolishing. Several parts can be installed on the central pressure sample holder. Large parts can also be treated individually.

The principle of high speed prepolishing on stone enables significant material removal and unrivalled flatness without rounding the edges.

The single block design and rigidity of the RECTILAM® 2.0 avoids vibration which is detrimental to the surface condition. In order to ensure significant and even removal of material, a reconditioning system automatically follows each stage of polishing.

The prepolishing system and the sample holder are connected to the same mechanical arm which guarantees precision.

The RECTILAM® 2.0 is supplied with an integral security hood. The assembly includes a closed-circuit lubricating filtration system integrated into the machine as well as a spray-tap for cleaning.



## RECTILAM® 2.0

Automatic flat prepolishing machine

*Prepolishing of large raw samples.*



*Prepolishing of coated samples, mounted on a central pressure sample holder.*





Grinding and prepolishing are crucial steps in the preparation of a metallographic sample. It is the quality of these steps which will condition and optimise the rest of the process.

At the end of the prepolishing step, the sample's aspect must be uniform and regular without any alteration of the inherent flatness of the material.

## PREPOLISHING MACHINE

### The RECTILAM®2.0's unique feature is its 2 axis principle.

The Z axis deals with the motorised rise and fall of the reconditioning tool and the pressurisation of the sample carrier.

The R axis enables precise positioning of the sample holder in relation to the grinding wheel in order to make most of the available abrasion surface.

During the start cycle the starting point of the sample/grinding wheel is automatic. The stock removal is continuously managed. The real-time display shows the operator if the rectification settings entered are appropriate.

All parameters are managed and clearly shown on the 5.7" touchscreen with graphic display.



Technical data	RECTILAM®2.0
Grinding wheel diameter	Ø 356 mm
Control	By 5.7 inch touchscreen and joystick
Grinding wheel speed	1000 to 3000 tr/min.
Sample holder speed	20 to 150 tr/min.
Applied force	10 to 550 N
Sample holder size	Ø 210 mm max
Conditioning wheel specifications	Configurable pass depth and diamond feed rate
In cycle reconditioning mode	Automatic - customisable frequencies
Stock removal range	0,1 mm to 1 mm
Measurement precision	0,02 mm
Work zone lighting	Enclosed LED
Body	Powder-coated steel
Grinding wheel motor power	3,8 kW
Sample holder motor power	0,25 kW
Noise level	70 dB
Tension	400 V-50 Hz three-phase + neutral
Dimensions W x H x D	900 x 1620 x 1000 mm (H. cover open : 1850 mm)
Weight	450 kg
Reference	60 RL200 00

### Accessories

Grinding wheel AL <sub>2</sub> O <sub>3</sub> - GRAIN 60 - Ø 355 mm	05 M0060 80
Grinding wheel SiC - GRAIN 150 - Ø 355 mm	05 M0150 80



05 M0060 80



05 M0150 80

The 5.7 inch touch screen





## SMARTLAM® 2.0



The SMARTLAM® 2.0 is a compact, single plate polishing machine that gives you a wide range of possibilities both in manual and semi-automatic polishing. Ergonomic and easy-to-use, the SMARTLAM® 2.0 is entirely controlled by a colour touch screen equipped with an intuitive interface. The internal memory can store 9 programs that can be exported via the USB port.

The power of the bidirectional rotation, variable-speed, constant-torque motor and the possibility to use plates with a diameter from 200 to 300 mm are exclusive assets that will allow you to face up to all situations encountered in metallographic research polishing.

### Evolution

Thanks to the mechanical pressure head option SPRINGLAM® and the central-pressure holders but also use of the M.M. 909 M programmable dosing unit slaved to the machine, you will have a very efficient, semi-automatic polishing system.

### Options: SPRINGLAM® pressure head to use the SMARTLAM® as a semi-automatic polisher

Variable pressure thanks to the 0- 250 N spring

Attachment system for central pressure sample-holder

Sample-holder Ø 119 mm 6 alveolus water drops for Ø 20 to 32 mm



## SMARTLAM® 2.0

The most versatile manual polishing machine

## 909 M DOSING UNIT

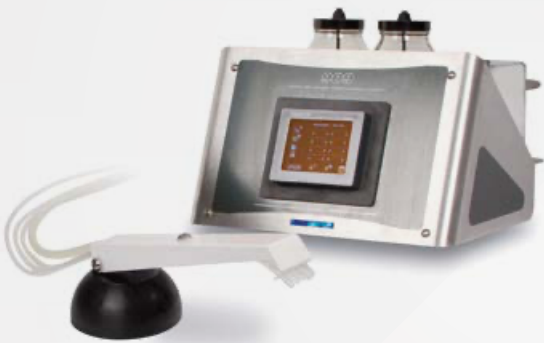

### M.M. 909 M dosing unit technical data

Distribution system	Distribution of 3 different liquids
Controls	Touch screen
Pumps	3 peristaltic pumps, with 1 outlet to drive an external pump
Electrical power supply	230 v single-phase 50 Hz
Dosing / machine communication	1 x 24 V input for machine servoing
Option	Replacement of a standard peristaltic pump by a high flow rate pump for high-viscosity products
Reference	08 00799 10



*Easy cleaning: spinning function, removable water input, easy tank removal*



Technical data	SMARTLAM® 2.0
Plate Capacity	Ø 200 to 300 mm
Body	Steel, coated with epoxy paint
Bowl	Removable resin basin for easy cleaning
Controls	3,5" touch screen to control the machine: start/stop, timer, speed and direction of plate, water solenoid valve
Plate rotation speed	Variable from 20 to 650 rpm
Rotation	Clockwise / counter-clockwise
Programming	Loads 9 programs
Connection	Slave connector for dosing unit
Water inlet	Removable pipe with flow-rate adjustment and safety solenoid valve
Power max	0,75 kW
Voltage	230 V - 50 Hz single-phase
Dimensions W x H x D	450 x 300 x 650 mm
Weight	30 kg
Reference	60 SL200 00

## POLISHING MACHINES

**SMARTLAM® 3.0**

With the SMARTLAM®3.0, LAM PLAN proposes an economic solution in terms of automatic pre-polishing and polishing of metallographic samples.

The SMARTLAM®3.0 is equipped with a new specific motorised head, composed with a 3 cells sample-holder and an individual pneumatic pressure system.

The moto reducer group has a high torque, the speed and the rotation can be set. The individual pneumatic pressure system handled by the electronic proportional valve, assures a great polishing regularity. The pressure applied per sample goes from 5 to 60 N.

The SMARTLAM®3.0 uses the reliable and proven base of the SMARTLAM®2.0 from which it conserves all the assets for a manual use (activation/deactivation of the sample holder head with the touch screen). The plate's speed and rotation can be set from 20 to 650 rpm.

For more efficiency, you can connect the M.M. 909 M automatic dosing unit to your SMARTLAM® 3.0 and benefit of a very economic and competitive set.

The automatic motorised head compactness is due to its strategically placed power supply on the side of the machine. The head rotates to free the workspace and allows the easy change of the polishing support and the cleaning of the plate and bowl.

All the functions accomplished by the machine or the head are controlled by the screen. The programs can be stored in the intern memory.

**NEW :** motorised head guidance to facilitate up/down manoeuvres and increase rigidity for better sample flatness.

Retrofit kit available: Réf. 60 SL220 20

Technical data	SMARTLAM®3.0
Plate Capacity	Ø 200 to 300 mm
Body	Steel coated with epoxy paint
Bowl	Removable resin basin for easy cleaning
Controls	3,5" touch screen to control the machine: start/stop, timer, speed and direction of plate, water solenoid valve
Plate rotation speed	Variable from 20 to 650 rpm
Rotation	Clockwise / counter-clockwise
Programming	Loads 9 programs
Connection	Slave connector for dosing unit
Water inlet	Removable pipe with flow-rate adjustment and safety solenoid valve
Power max	0,75 kW
Voltage	230 V - 50 Hz single-phase
Pneumatic feed	6 bars, filtered 50 µm
Dimensions W x H x D	580 x 570 x 670 mm
Weight	65 kg
Reference	60 SL220 00



Friendly interface with large 3,5 " touch screen

**SMARTLAM® 3.0**

Individual pressure semi-automatic polishing machine

**Technical data of the head**

Capacity	3 samples Ø 25,4 to 50 mm (on Ø 200 mm plate 3 samples Ø 30 mm max.)
Body	Steel coated with epoxy paint
Controls	Colour touch screen (3"): controls the machine and the head
Sample holder rotation speed	Variable from 10 to 150 rpm
Rotation	Clockwise / counter-clockwise
Pressure	Individual, pneumatic, variable from 5 to 60 N
Programming	Loads 9 programs
Power max	Moto reducer with high torque
Positioning	Manual, with indexable handle
Positioning and locking in height	Manual, raising/lowering of the head with a lever, locking with knob





## MASTERLAM<sup>®</sup> 1.0

Automatic polishing machine with central pressure, oscillating head\* and stock removal control\*

\* Optional equipment available



### Options

Dosing unit DISTRILAM (4 circuits)	60 MLD00 00
Oscillation function	
Stock removal control system	60 ML10S C0
Transparent secured housing for MASTERLAM <sup>®</sup>	60 MLEP0 00
Filtering / sedimentation 60 L tank, recirculation pump	60 A0029 00
Filtering / decantation 60 L tank	60 A0029 90

### Accessories (See next page)



## MASTERLAM<sup>®</sup> 1.0

MADE IN FRANCE

Automatic, single-plate Ø 250 to 300 mm polishing machine with bidirectional rotation and variable speed. Touch screen controls, intuitive and user friendly interface, MASTERLAM<sup>®</sup> machines are equipped with the best programming, parameter storage and export technologies. Control of the 4-circuit DISTRILAM<sup>®</sup> dosing unit directly integrated.

The MASTERLAM<sup>®</sup> 1.0 is equipped with a powerful central-pressure head, bidirectional rotation, variable speed and pressure. The distinctive feature of this polishing head is the oscillation function with oscillation configurable both for amplitude and frequency.

The use of the oscillating head will allow you to achieve unrivalled levels of performance and versatility: it improves the quality of flatness, increases the stock removable and the service life of polishing supports (uniform wear due to the use of the entire surface of the plate.)

La MASTERLAM<sup>®</sup> 1.0 with the oscillation option, is particularly efficient for polishing large-sized samples and for superfinishing of mechanical components, prototypes or micro-series.

A stock removal control system with an automatic "stop at measurement" function is also available (accurate to 0,02 mm).

The MASTERLAM<sup>®</sup> 1.0 is a high-performance machine intended for intensive use such as in-production inspections.

Technical data	MASTERLAM <sup>®</sup> 1.0
Plate Capacity	Ø 250 to 300 mm
Body	Steel coated with epoxy paint
Bowl	Removable, in resin, to ease cleaning
Controls	Touch screen (5,7")
Plate rotation speed	Variable from 20 to 650 rpm Bidirectional rotation
Head's speed	Variable from 10 to 150 rpm bidirectional rotation
Applicable load	5 to 400 N central pressure
Capacity	Sample size in central pressure 6 x Ø 40 mm
Head oscillation function	Adjustable speed and amplitude (optional)
Stock removal control function	Stock removal measuring system with automatic stop, accurate to 0.02 mm (optional)
Workspace lightening	LED
Water inlet	Removable pipe, with flow rate adjustment and safety solenoid valve
Programming	60 storable programs, USB connector to backup programs and Ethernet port for networking
Cumulative machine power	1.1 kW
Voltage	230 V - 50 Hz single phase
Pneumatic feed	6 bars
Dimensions W x H x D	550 x 670 x 670 mm
Weight	80 kg
Reference	60 ML100 00

## POLISHING MACHINES

**MASTERLAM® 3.0**

MADE IN FRANCE

Automatic, single plate Ø 250 to 300 mm polishing machine, bidirectional rotation and variable speed.

This machine has all the functions that make the MASTERLAM® range stand out and on this model a specific new combo-head. The MASTERLAM® 3.0 is the metallographic polishing machine without concession. Polishing can be carried out with central pressure or individual pressure and can be equipped with a stock removal measuring system.

The MASTERLAM® 3.0 is based on the same technology as the MASTERLAM® 1.0 with, in this configuration, a powerful central and individual pressure head equipped with 6 pistons.

Changing sample holders is quick and the pressure mode is controlled directly on the screen without having to touch the head, thus, you can switch from one pressure mode to another in a few seconds.

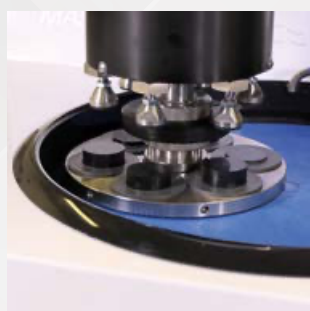

Central pressure mode

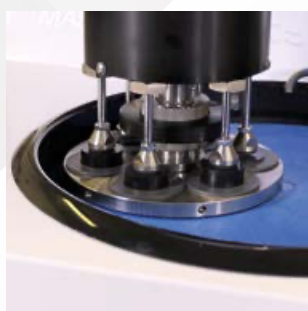

Individual pressure mode

**MASTERLAM® 3.0**

Automatic polishing machine with central and individual pressure

**Options**

Dosing unit DISTRILAM (4 circuits)	60 MLD00 00
Stock removal control system	60 ML305 C0
Transparent secured housing for MASTERLAM®	60 MLEPO 00
Filtering / sedimentation 60 L tank, recirculation pump	60 A0029 00
Filtering / decantation 60 L tank	60 A0029 90



60 MLD00 00



60 MLEPO 00



60 A0029 00

Technical data	MASTERLAM® 3.0
Plate Capacity	Ø 250 to 300 mm
Body	Steel coated with epoxy paint
Bowl	Removable resin bowl for easy cleaning
Controls	Touch screen (5,7")
Plate rotation speed	Variable from 20 to 650 rpm Bidirectional rotation
Head's speed	Variable from 10 to 150 rpm bidirectional rotation
Applicable load	5 to 400 N central pressure 5 to 100 N individual pressure
Capacity	Sample size 6 X Ø 40 mm Sample size 1 - 6 X Ø 50 mm
Workspace lightening	LED
Water inlet	Removable pipe, with flow rate adjustment and safety solenoid valve
Programming	60 storable programs, USB connector to backup programs and Ethernet port for networking
Cumulative machine power	1.1 kW
Voltage	230 V - 50 Hz single phase
Pneumatic feed	6 bars
Dimensions W x H x D	550 x 670 x 670 mm
Weight	85 kg
Reference	60 ML300 00

**Accessories for MASTERLAM® 1.0 and 3.0**

Aluminium removable plate Ø 250 mm
Aluminium removable plate Ø 300 mm
Sample-holder: CP (central pressure) and IP (Individual pressure)



Aluminium plate



IP sample-holder



CP sample-holder

Ø 160 mm central pressure sample holder for eccentric restriction of non-embedded complex geometric parts.

06 MLC60 00

NEW





## MASTERLAM® 1.1



Automatic single-plate Ø 350 to 400 mm polishing machine, bidirectional rotation and variable speed.

The MASTERLAM® 1.1 is a central pressure machine. It is equipped with a 2,2 Kw main motor, a 250 W head motor and applicable pressure may reach 450 N.

Using the oscillating head allows you to make use the entire surface of the 350 or 400 mm diameter plate: the quality of flatness is improved, stock removal is increased and the service life of polishing supports is increased (uniform wear due to use of the entire surface of the plate.)

The specific capacities of the MASTERLAM® 1.1 allow it to cope with most difficult applications, particularly in terms of large polishing surfaces where the torque and required pressure exceed the capabilities of standard equipment.



**MASTERLAM® 1.1**  
Large diameter, automatic polishing machine with central pressure and motorised oscillating head



*DISTRILAM dosing unit programming integrated to the machine's commands in the full range of MASTERLAM® machines.*

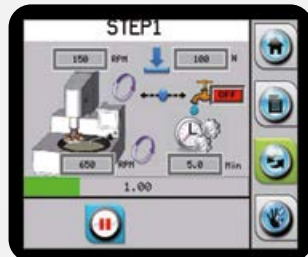

*Possibility of changing parameters while the machine is working: pressure, speed, time and dosage (except the rotation.)*

### Options

Dosing unit DISTRILAM®	60 MLD00 00
Filtering / sedimentation 60 L tank, recirculation pump	60 A0029 00
Filtering / decantation 60 L tank	60 A0029 90
Transparent secured housing for the MASTERLAM® 1.1	60 MLEP1 00



60 MLD00 00



60 MLEP1 00



60 A0029 00

Technical data	MASTERLAM® 1.1
Plates Capacity	Ø 350 to 400 mm
Body	Steel coated with epoxy paint
Bowl	Removable, in resin, to ease cleaning
Controls	Touch screen (5,7")
Plate rotation speed	Variable from 20 to 650 rpm Bidirectional rotation
Head's speed	Variable from 10 to 150 rpm bidirectional rotation
Applicable load	5 to 450 N central pressure
Capacity	Sample size 6 X Ø 60 mm
Oscillating head (option)	Adjustable speed and amplitude
Workspace lightening	LED
Water inlet	Removable pipe, with flow rate adjustment and safety solenoid valve
Programming	60 storable programs, USB connector to backup programs and Ethernet port for networking
Motor power	2.2 kW
Head motor power	250 W
Voltage	230 V - 50 Hz single phase (25A)
Pneumatic feed	6 bars
Dimensions W x H x D	800 x 597 x 712 mm
Weight	110 kg
Reference	60 ML110 00

## POLISHING MACHINES

## Dosing unit DISTRILAM®

MADE IN FRANCE

The automatic dosing unit DISTRILAM® is directly controlled via the touch screen on the machine through a RS 232 connector. It is instantly recognised by all the MASTERLAM® polishing devices as the control program is already programmed in the machines. It is equipped with 4 circuits composed of 3 standard peristaltic pumps for an accurate dosage of diamond liquids, and 1 high flow rate peristaltic pump for the dosage of the lubricant or the colloidal silica abrasive. It works without compressed air nor electric wiring.

The automatic dosing unit DISTRILAM® is an indispensable accessory for an automatic use of the MASTERLAM®.

This device is the guarantee of a reproducible process and an economic use of the fluids.

It contains: a dosing unit, a machine connection, a 4 ways distribution nozzle on magnetic leg and 4 plastic bottles.

Technical data	DISTRILAM®
Dimensions L x H x P	170 x 205 x 200 mm
Reference	60 MLD00 00

## Transparent protective housing

The secured housing is a totally transparent protection compatible with the full range of MASTERLAM®.

Its opening stops all movements of the machine\*, it offers an integral protection complying with the 2006/42/ CE and 2004/108/CE standards. The housing's design preserves the accessibility of the plate and does not clutter the workspace.

The touch screen is located outside of the secured zone; therefore, the commands are permanently accessible.

For the MASTERLAM®1.0 and 3.0 the touch screen control panel is located on the right, a 195 mm space needs to be foreseen in addition to the machine width.

*\*However, the transparent secured housing authorises the plate rotation in the manual mode.*



Technical data	Housing for MASTERLAM® 1.0 et 3.0
Required space	Width 770 mm - Height 910 mm
Reference	60 MLEP0 00

Technical data	Housing for MASTERLAM® 1.1
Required space	Width 880 mm - Height 910 mm
Reference	60 MLEP1 00

## DISTRILAM®



3 standard pumps and  
1 high flow rate pump



## Accessories for polishing machines

Designation	Ref.	SMARTLAM®		MASTERLAM®		
		2.0	3.0	1.0	3.0	1.1
<b>PLATES AND SUPPORTS</b>						
Aluminium plate Ø 200 mm	08 8270100	✓	✓			
Aluminium plate Ø 230 mm	08 8270200	✓	✓			
Aluminium plate Ø 250 mm	08 8270300	✓	✓	✓	✓	
Aluminium plate Ø 300 mm	08 8270400	✓	✓	✓	✓	
Aluminium plate Ø 400 mm	08 8270600					✓
Metal clamping ring for Ø 200 mm plate	60 SL00290	✓	✓			
Metal clamping ring for Ø 230 mm plate	60 SL00190	✓	✓			
Metal clamping ring for Ø 250 mm plate	60 SL00490	✓	✓	✓	✓	
Metal clamping ring for Ø 300 mm plate	60 SL00690	✓	✓	✓	✓	
Metal clamping ring for Ø 305 mm plate	60 SL00790	✓	✓	✓	✓	
Tank reducer SMARTLAM® for Ø 200 mm plate	60 ML08090	✓	✓			
Tank reducer SMARTLAM® for Ø 230 mm plate	60 ML08290	✓	✓			
Tank reducer SMARTLAM® for Ø 250 mm plate	60 ML08190	✓	✓	✓	✓	
Anti-splash ring pour MASTERLAM® & SMARTLAM®2.0	60 ML08091	✓		✓	✓	
<b>SAMPLE HOLDERS AND ACCESSORIES</b>						
CP sample holder Ø 119 mm with 6 x Ø 20 to 32 mm water drop cells	06MLP0200	✓*				
CP sample holder Ø 160 mm with 6 x Ø 20 to 40 mm water drop cells	06MLC1000	✓*		✓	✓	
CP sample holder Ø 160 mm 9 x Ø 30 mm	06MLC3000	✓*		✓	✓	
CP sample holder Ø 160 mm 6 x Ø 40 mm	06MLC4000	✓*		✓	✓	
CP sample holder Ø 160 mm 5 x Ø 50 mm	06MLC5000	✓*		✓	✓	
CP sample holder Ø 160 mm with 3 x rectangular 40 x 70 mm	06MLC1200	✓*		✓	✓	
CP sample holder Ø 160 mm with 6 x rectangular 25 x 34 mm	06MLC1400	✓*		✓	✓	
CP sample holder Ø 210 mm without cavity	06MLC0100					✓
IP sample holder Ø 160 mm 6 x Ø 50 mm	06MLI1000				✓	
Sample holder Ø 160 mm for irregular parts	06MLC6000			✓	✓	✓
Kit 6 x Ø 40 mm reducer rings	06MLIK500				✓	
Kit 6 x Ø 30 mm reducer rings	06MLIK200				✓	
Kit 6 x Ø 25,4 mm reducer rings	06MLIK110				✓	
Kit 6 x 1-1/4" reducer rings	06MLIK310				✓	
Kit 6 x 1-1/2" reducer rings	06MLIK410				✓	
Kit 3 x Ø 40 mm reducer rings	06SLIK500		✓			
Kit 3 x Ø 30 mm reducer rings	06SLIK200		✓			
Kit 3 x Ø 25,4 mm reducer rings	06SLIK110		✓			
Kit 3 x 1-1/4" reducer rings	06SLIK310		✓			
Kit 3 x 1-1/2" reducer rings	06SLIK410		✓			
Levelling plate for CP sample holder Ø 160 mm - 3 mm depth	06MLP0100				✓	✓
Levelling plate for CP sample holder Ø 119 mm - 3 mm depth	06MLP0200	✓*	✓			
<b>DISTRIBUTORS</b>						
Automatic dosing unit DISTRI LAM® for MASTERLAM®	60 MLD00 00			✓	✓	✓
Automatic dosing unit M.M. 909 M for SMARTLAM®	080079910	✓*	✓			

\* SMARTLAM® 2.0 equipped with the SPRINGLAM®





## ACCESSORIES FOR POLISHING MACHINES

## Diaphragm compressor

Diaphragm compressor for laboratories that are not equipped with a compressed air network. Silent operating.

Flow	Pressure	Dim. W x H x P	Ref.
50 l/min	8 bar	330 x 500 x 330 mm	60 COM00 00

## Pressure regulator filter kit for compressed air

Indispensable to preserve the machines from impurities. Compatible with: CUTLAM®4.0 and CUTLAM®5.0, PRESSLAM®1.1, SMARTLAM®3.0, MASTERLAM®1.0/1.1/3.0.

Ref. : 60 00375 90

## Universal sample-holder mould

The LAM PLAN universal sample-holder mould is a smart and economical system which combines the functions of both mounting mould and sample-holder for cold mounting processes using any kind of liquid resin. This system has been developed as two removable parts: the metallic universal sample-holder with non-stick coating and a special silicon based flexible mould to embed your cold mounting samples.

### Use

The 610 sample holder can be used on both automatic and semi-automatic machines. It is directly compatible with the SMARTLAM®2.0 fitted with the SPRINGLAM® pressure arm. An adaptor kit is available for use with an automatic machine with motorised head.

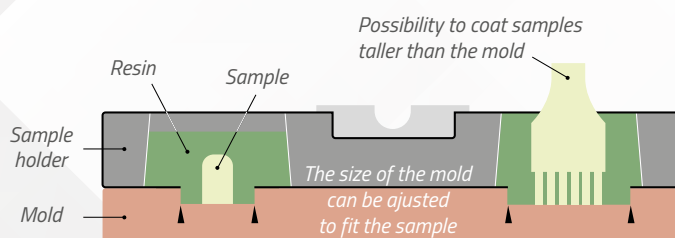

### SERIE 610

Designation	Ref.	SMARTLAM® option SPRINGLAM®	MASTERLAM®
		2.0	1.0 and 3.0
Ø 110 mm with 6 x Ø 28 mm cells	06 00612 20	Ø 200 mm	
Ø 145 mm 3 moulds 6 included cells 6 x Ø 40, 6 x Ø 35 and 6 x Ø 32 mm	06 00614 10	Ø 250 - 300 mm	Ø 250 - 300 mm
Ø 145 mm with 3 moulds 6 included cells 6 x Ø 30, 6 x Ø 25 and 6 x Ø 20 mm	06 00614 20	Ø 250 - 300 mm	Ø 250 - 300 mm
Ø 145 mm with moulds 3 x Ø 50 mm cells	06 00614 30	Ø 250 - 300 mm	Ø 250 - 300 mm
Ø 145 mm with 2 moulds 3 included rectangular cells 3 x 30 x 55 mm and 3 x 18 x 55 mm	06 00614 40	Ø 250 - 300 mm	Ø 250 - 300 mm
Ø 160 mm with mould 6 x Ø 36 mm cells	06 00612 40	Ø 250 - 300 mm	Ø 250 - 300 mm
Ø 160 mm with mould 10 x Ø 28 mm cells	06 00612 50	Ø 300 mm	Ø 300 mm
Universal sample holder ADAPTOR KIT for MASTERLAM®1.0 and 3.0	06 K0010 00		✓

In order to use the universal sample-holders with the SMARTLAM®2.0, the machine must be fitted with a SPRINGLAM® pressure arm. The universal sample-holders are not compatible with the individual pressure.



Position-tracing line to remove and replace coated item

SPRINGLAM® pressure arm for SMARTLAM®2.0





Adhesive disc on FAS<sup>®</sup>2 support

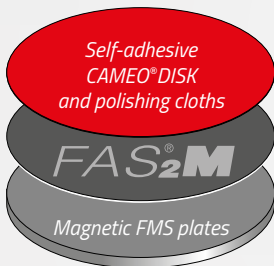

Magnetic CAMEO<sup>®</sup> DISK

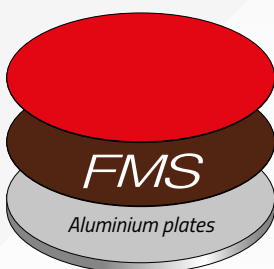

## Fixing accessories

The discs and plates FAS<sup>®</sup>2, FMS<sup>®</sup>, X LAM<sup>®</sup>, FIX LAM<sup>®</sup> and XLAM 4 allow you to easily fix all your discs whether self-adhesive or not, for simplified manipulation.

### FAS<sup>®</sup>2 DISCS

The solution for adhesive fixing

The FAS<sup>®</sup>2 facilitates the sticking and unsticking of all self-adhesive supports (abrasive papers, grinding and polishing discs). It avoids the time consuming cleaning of plates dirtied by glue remains whenever a self-adhesive disc is removed.

The patented material comprising the FAS<sup>®</sup>2 system allows combining the softness and regularity of the abrasion of a flexible coating with the inherent flatness obtained with a metal support.

Available in 2 versions:

- FAS<sup>®</sup>2: rigid self-adhesive, fixed to your machine's plate, available in all diameters, its low thickness (1 mm) guarantees the initial inherent flatness of the master plate.
- FAS<sup>®</sup>2-M: suitable for machines equipped with magnetic base plates or when the LAM PLAN FMS disc is used. The FAS<sup>®</sup>2-M has 2 usable sides, it is therefore reversible, when one side is damaged the other can be used.

Characteristics	Qty.	Ø in mm	Ref.
-----------------	------	---------	------

#### FAS<sup>®</sup>2

Self-adhesive backside	1	200	05 FAS20 20
	1	250	05 FAS20 40
	1	300	05 FAS20 50
	1	400	05 FAS20 80

#### FAS<sup>®</sup>2-M

Magnetic backside	1	200	05 FAS2M 20
	1	250	05 FAS2M 40
	1	300	05 FAS2M 50
	1	400	05 FAS2M 80

### FMS<sup>®</sup> PLATES AND DISCS

The fixing system by magnetic attachment.

The FMS<sup>®</sup> magnetic disc sticks to all type of support plates. It is also available in an FMS plate and adapts to all existing machines.

Characteristics	Qty.	Ø in mm	Ref.
-----------------	------	---------	------

#### FMS<sup>®</sup> DISCS

Self-adhesive backside	1	200	08 82801 10
	1	230	08 82802 10
	1	250	08 82803 10
	1	300	08 82804 10
	1	400	08 82807 10

#### FMS<sup>®</sup> PLATES

Aluminium plate equipped with a FMS <sup>®</sup> adaptable disc on polishing machine	1	200	08 82801 00
	1	230	08 82802 00
	1	250	08 82803 00
	1	300	08 82804 00
	1	400	08 82807 00

## FIXING ACCESSORIES

**FIX LAM® DISCS AND PLATES****The repositionable adhesive system.**

The FIX LAM® allows you to maintain non-adhesive abrasive papers thanks to a repositionable adhesive surface.

- **FIX LAM®**: adhesive backside.
- **FIX LAM®-M**: magnetic backside.

Characteristics	Qty.	Ø in mm	Ref.
-----------------	------	---------	------

**FIX LAM® DISCS**

Adhesive backside	5	200	05 40000 20
	5	230	05 40000 30
	5	250	05 40000 40
	5	300	05 40000 60

**FIX LAM®-M DISCS**

Magnetic backside	5	200	05 4000M 20
	5	230	05 4000M 30
	5	250	05 4000M 40
	5	300	05 4000M 60

**XLAM 4** NEW**New fixing for polishing discs Serie X.**

The XLAM 4 is an innovative product for fixing non-self adhesive polishing discs on metallographic polishing machines by contact. The XLAM 4 is a thin disc to be fixed on the machine plate. Its special surface enables the adherence of XLAM series discs without self adhesive, so polishing supports are quickly and effortlessly interchangeable. Polishing discs can easily be stored and reused.

The XLAM 4 enables easy transition between the different polishing steps and so reduces the time needed for sample preparation.

Characteristics	Qty.	Ø in mm	Ref.
-----------------	------	---------	------

**XLAM 4**

Adhesive backside	1	200	04 XLAM4 20
	1	250	04 XLAM4 40
	1	300	04 XLAM4 50
	1	400	04 XLAM4 80

**XLAM 4-M**

Magnetic backside	1	200	04 XLAM4M20
	1	250	04 XLAM4M40
	1	300	04 XLAM4M50
	1	400	04 XLAM4M80

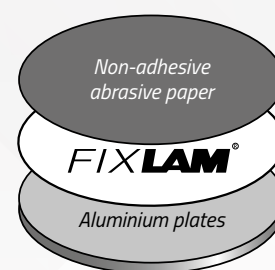

Examples of implementation adhesive version

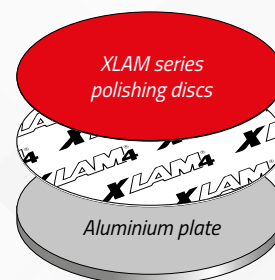

Examples of implementation magnetic version

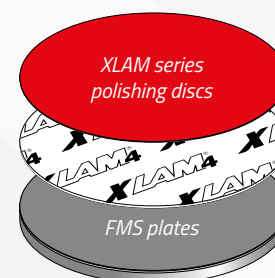
**Applications table**

Your machine is equipped with		Compatible supports
Aluminium plate	Magnetic plate	
FIX LAM®	FIX LAM®-M	Non-adhesive abrasive paper
FAS®2	FAS®2-M	Self-adhesive CAMEO DISK® - Self-adhesive abrasive paper - Self-adhesive polishing cloth
FMS®	-	Magnetic CAMEO DISK® - Magnetic polishing cloth
XLAM 4	-	Magnetic CAMEO DISK®
XLAM 4	XLAM 4-M	Polishing disc XLAM series

**GUIDANCE**

Extend the service life of your discs thanks to the discs and plates storage system.



## BOX LAM® 300

The BOX LAM® 300 allows storing discs and plates, up to Ø 300mm. Delivered with 10 sliding aluminium shelves, which may be equipped, among others, with a foam template to store your samples. The large transparent cover and the shelf arrangement allow an optimum visibility of the stored products.

Characteristics	Qty.	Dim. (mm)	Ref.
Storage for 10 discs or plate up to Ø 300 mm and storage for samples (according to options)	1	W 400 x H 470 x D 490	08 BL300 00

## BOX LAM® 300 accessories

Characteristics	Qty.	Dim. (mm)	Ref.
-----------------	------	-----------	------

### FOAM TEMPLATE

Storage template for samples, self-adhesive foam	2	W 320 x H 10 x D 330	08 BL300 20
--	---	----------------------	-------------

### "DIAMOND" PLEXIGLASS SHELF

Self-adhesive diamond tip plexiglas shelf specially studied for the storage of adhesive discs	2	W 320 x H 2 x D 330	08 BL300 40
---	---	---------------------	-------------

### PVC PROTECTION

Self-adhesive protection sheet made of smooth white PVC	10	W 320 x D 330	08 BL300 60
---	----	---------------	-------------

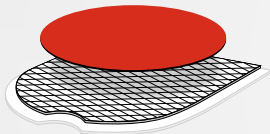
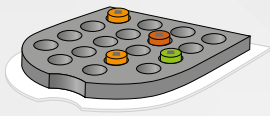

## BOX LAM®

The BOX LAM® is an economic unit to arrange and store in a dust-free space grinding and polishing discs, specially for self-adhesive cloths up to Ø 300 mm. The BOX LAM® is equipped with a transparent closing flap, 6 shelves and a storage drawer.

Characteristics	Qty.	Dim. (mm)	Ref.
Economic model with 6 shelves	1	W 340 x H 450 x D 340	08 BL100 00

## CLEANING AND STORAGE ACCESSORIES

## COVER LAM®

The COVER LAM® is a self-adhesive protection disc which is applied on clean and polished samples to efficiently preserve their surface condition and protect it from ambient environment attacks. The COVER LAM® does not require any cleaning of the polished sample after its has been removed.

Characteristics	Qty.	Ø in mm	Ref.
Disc for the protection of metallographic samples after polishing	100	50	08 COV00 00



## Ultrasonic cleaning

### The efficiency of ultrasonic cleaning

The ultrasonic process is the most used to clean parts because it guarantees a rapid and efficient result, while avoiding the deterioration of the material. 2 tank capacities are available: 0.8 and 2.75 litres.

The tank consisting of a container and a basket made of stainless steel is equipped with a timer from 0 to 30 minutes.

Characteristics	Qty.	Capacities	Ref.
<b>ULTRASONIC TANK M.M.80</b> Stainless steel container with stainless steel basket Timer from 0 to 30 minutes	1	0,8 L	60 US100 00

### ULTRASONIC TANK M.M.275

Stainless steel container with stainless steel basket Timer from 0 to 30 minutes	1	2,75 L	60 US200 00
---	---	--------	-------------



## Detergent

Characteristics	Qty.	Ref.
<b>DETERGENT 742</b> Detergent for ultrasonic cleaning tank (dilution < 10 % in water)	5 litres 1 litre	08 01742 10 08 01742 00



## Technical wipings

### Technical wiping of samples without micro-scratches

The LAM® 15 cloth allows you to eliminate and wipe off easily the halos left by cleaning liquids or water.

Characteristics	Qty.	Ref.
<b>LAM 15</b> Cloths 320 x 400 mm	2 x 24 cloths	08 LAM15 00
Cloths Ø 80	400 cloths	08 LAM15 20



## Abrasive papers SiC STANDARD

Available from P80 to P4000 from  $\varnothing$  200 to 400 mm.

The LAM PLAN® abrasive papers respond to very strict quality standards. The calibration of the silicon carbide grains is guaranteed for the European standards FEPA regardless of their size (P80 to P4000).

The resistance of the resins used to maintain the abrasive grains gives to the LAM PLAN® abrasive papers a high resistance to heat and moisture. The orientation of the grains is obtained by an electrostatic process. The choice of the support paper (thickness and basis weight) is adapted to the grain's thickness in order to reduce the wear of the abrasive papers. The paper is made impermeable in its mass and on the surface.



### $\varnothing$ 200 mm

### $\varnothing$ 230 mm

100 pieces box

Grains FEPA	Self-adhesive		Non-adhesive	
	Ref.	Ref.	Ref.	Ref.
P80	05 60080 20	05 50080 20	05 60080 30	05 50080 30
P120	05 60120 20	05 50120 20	05 60120 30	05 50120 30
P180	05 60180 20	05 50180 20	05 60180 30	05 50180 30
P240	05 60240 20	05 50240 20	05 60240 30	05 50240 30
P320	05 60320 20	05 50320 20	05 60320 30	05 50320 30
P400	05 60400 20	05 50400 20	05 60400 30	05 50400 30
P600	05 60600 20	05 50600 20	05 60600 30	05 50600 30
P800	05 60800 20	05 50800 20	05 60800 30	05 50800 30
P1000	05 61000 20	05 51000 20	05 61000 30	05 51000 30
P1200	05 61200 20	05 51200 20	05 61200 30	05 51200 30
P2400	05 62400 20	05 52400 20	05 62400 30	05 52400 30
P4000	05 64000 20	05 54000 20	05 64000 30	05 54000 30



### $\varnothing$ 250 mm

### $\varnothing$ 300 mm

100 pieces box

Grains FEPA	Self-adhesive		Non-adhesive	
	Ref.	Ref.	Ref.	Ref.
P80	05 60080 40	05 50080 40	05 60080 50	05 50080 50
P120	05 60120 40	05 50120 40	05 60120 50	05 50120 50
P180	05 60180 40	05 50180 40	05 60180 50	05 50180 50
P240	05 60240 40	05 50240 40	05 60240 50	05 50240 50
P320	05 60320 40	05 50320 40	05 60320 50	05 50320 50
P400	05 60400 40	05 50400 40	05 60400 50	05 50400 50
P600	05 60600 40	05 50600 40	05 60600 50	05 50600 50
P800	05 60800 40	05 50800 40	05 60800 50	05 50800 50
P1000	05 61000 40	05 51000 40	05 61000 50	05 51000 50
P1200	05 61200 40	05 51200 40	05 61200 50	05 51200 50
P2400	05 62400 40	05 52400 40	05 62400 50	05 52400 50
P4000	05 64000 40	05 54000 40	05 64000 50	05 54000 50

## GRINDING AND PREPOLISHING DISCS

## Ø 305 mm

## Ø 400 mm

100 pieces box

Grains FEPA	Self-adhesive		Non-adhesive	
	Ref.	Ref.	Ref.	Ref.
P80	05 60080 70	05 50080 70	05 60080 80	05 50080 80
P120	05 60120 70	05 50120 70	05 60120 80	05 50120 80
P180	05 60180 70	05 50180 70	05 60180 80	05 50180 80
P240	05 60240 70	05 50240 70	05 60240 80	05 50240 80
P320	05 60320 70	05 50320 70	05 60320 80	05 50320 80
P400	05 60400 70	05 50400 70	05 60400 80	05 50400 80
P600	05 60600 70	05 50600 70	05 60600 80	05 50600 80
P800	05 60800 70	05 50800 70	05 60800 80	05 50800 80
P1000	05 61000 70	05 51000 70	05 61000 80	05 51000 80
P1200	05 61200 70	05 51200 70	05 61200 80	05 51200 80
P2400	-	05 52400 70		
P4000	-	05 54000 70		



## Grain sizes

FEPA standard	80	120	180	240	320	400	600	800	1000	1200	2400	4000
Grains Ø (microns)	201	125	82	59	46	35	26	22	18	15	10	5

## GUIDANCE

The patented FAS<sup>2</sup> system is the indispensable accessory when using self-adhesive discs. The FAS<sup>2</sup> is a support disc which allows easy positioning and unsticking of self-adhesive abrasive papers on all machines.

See all our fastening systems pages FIXING ACCESSORIES

Abrasive paper  
SELF-ADHESIVE

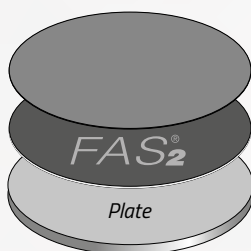

FAS<sup>2</sup> non-stick backing for paper and self-adhesive discs

Abrasive paper  
SELF-ADHESIVE  
used with its protective film

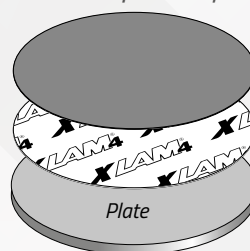

XLAM<sup>4</sup> adhesive backing for paper and discs non-adhesive

Abrasive paper  
NON-ADHESIVE

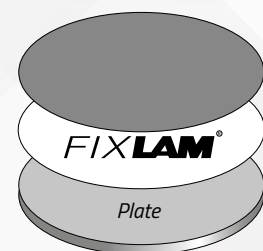

FIXLAM<sup>®</sup> adhesive backing for paper and discs non-adhesive



## Abrasive papers SiC EXCELLENCE

Available from P80 to P1200 from Ø 200 to 300 mm

The standard checks of abrasive papers generally manufactured in large quantities are sometimes insufficient to avoid that complete series of discs are outside the standard required by our Metallography laboratory.

LAM PLAN creates the Excellence Range and its double guarantee, every single paper is individually checked before packing.

### Ø 200 mm

Self-adhesive			Non-adhesive	
Grains FEPA	Ref.	Ref.	Ref.	Ref.
P80	05 10080 20	05 00080 20	05 10080 30	05 00080 30
P120	05 10120 20	05 00120 20	05 10120 30	05 00120 30
P180	05 10180 20	05 00180 20	05 10180 30	05 00180 30
P240	05 10240 20	05 00240 20	05 10240 30	05 00240 30
P320	05 10320 20	05 00320 20	05 10320 30	05 00320 30
P400	05 10400 20	05 00400 20	05 10400 30	05 00400 30
P600	05 10600 20	05 00600 20	05 10600 30	05 00600 30
P1200	05 11200 20	05 01200 20	05 11200 30	05 01200 30

### Ø 230 mm

50 pieces box

### Ø 250 mm

Self-adhesive			Non-adhesive	
Grains FEPA	Ref.	Ref.	Ref.	Ref.
P80	05 10080 40	05 00080 40	05 10080 50	05 00080 50
P120	05 10120 40	05 00120 40	05 10120 50	05 00120 50
P180	05 10180 40	05 00180 40	05 10180 50	05 00180 50
P240	05 10240 40	05 00240 40	05 10240 50	05 00240 50
P320	05 10320 40	05 00320 40	05 10320 50	05 00320 50
P400	05 10400 40	05 00400 40	05 10400 50	05 00400 50
P600	05 10600 40	05 00600 40	05 10600 50	05 00600 50
P1200	05 11200 40	05 01200 40	05 11200 50	05 01200 50

### Ø 300 mm

50 pieces box

## Grinding wheels

LAM PLAN grinding wheels are used to dress samples in high speed automatic prepolishing machines. Two types available:  $Al_2O_3$  grain 60 and SiC grain 150.



### $Al_2O_3$ - GRAIN 60

Application	Lubricant	Ø in mm	Ref.
For grinding of soft, ductile materials <HV200	Water	355	05 M0060 80

### SIC - GRAIN 150

Application	Lubricant	Ø in mm	Ref.
For grinding of all materials >HV200	Water	355	05 M0150 80



## CAMEO®DISK

Grinding and polishing are key steps in the preparation of a metallographic sample. It is the quality of these steps which will condition and optimise the rest of the process.

At the end of the grinding step, the sample's aspect must be uniform and regular without altering the inherent flatness and the material. The CAMEO®DISK's performances in terms of stock removal reduce the work time on the part, thereby guaranteeing the sample's inherent flatness, an indispensable condition to succeed with your metallographic analyse.

### Stock removal

The CAMEO®DISK honeycomb cell structure allows decreasing the surface in contact with the sample to be polished. The pressure required to grind the sample is much less than that generally applied during the use of a solid disc. The equipment is less stressed and the risks of tearing out the grinding disc are significantly reduced.

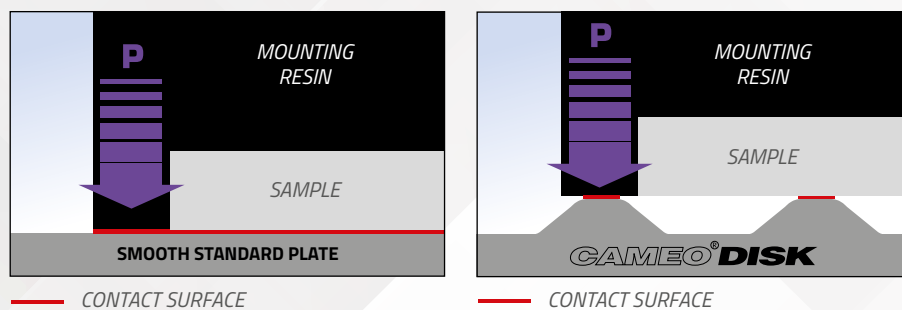

### Reproducibility

The profile of the honeycomb cells was specially designed to optimise the circulation of the lubricant from one cavity to another. The abrasion residues are evacuated, guaranteeing a constant abrasive power and therefore a regularity of the result throughout the grinding and polishing steps.

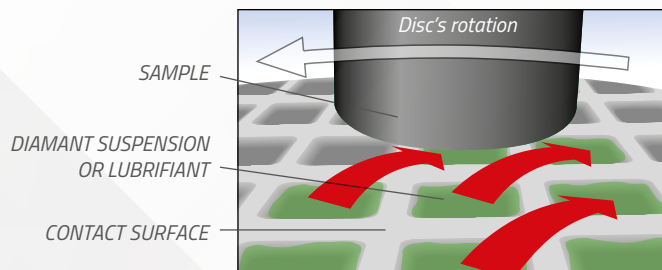

### Preparation quality

For a process usually performed with several SiC abrasive papers, LAM PLAN proposes you a single, reusable disc: the CAMEO®DISK. Contrary to SiC abrasive papers, CAMEO®DISK constant abrasion prevents the formation of deep disturbed layers during the first few seconds of grinding.

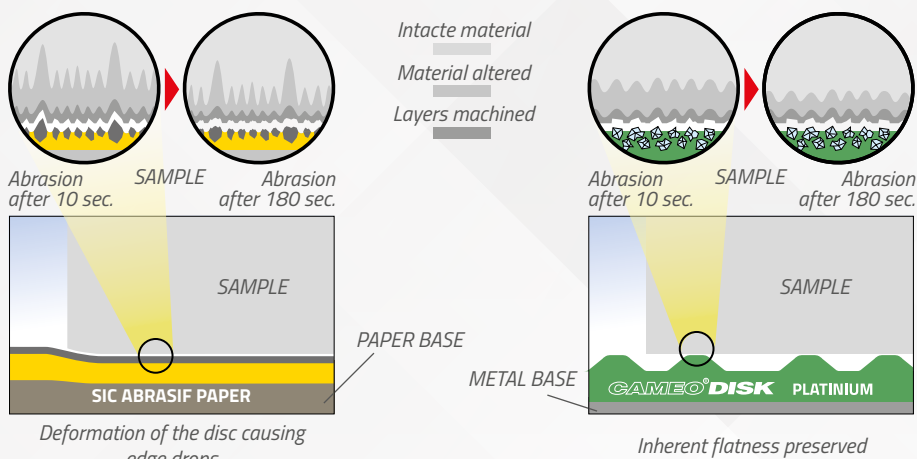

CAMEO®DISK

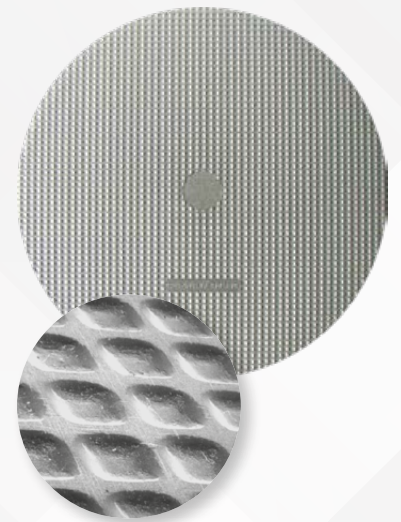

A patented honeycomb cell structure



## CAMEO®DISK Platinum

The CAMEO®DISK Platinum are diamond discs (fixed abrasive) which are ideal for a rapid grinding of metallographic samples.

The use of diamond integrated in the CAMEO®DISK Platinum honeycomb cell structure allows preserving a constant stock removal throughout the operation, which prevents the appearance of edge drops, including on samples of heterogeneous hardnesses.

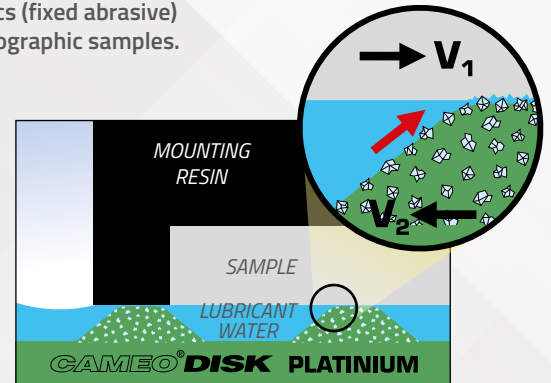

Platinum 0



Platinum 1

Platinum 2



Platinum 3

Platinum 4



### PLATINIUM 0 BROWN

Ø in mm	Self-adhesive	Magnetic
	Ref.	Ref.
200	09 CA170 20	09 CA570 20
230	09 CA170 30	09 CA570 30
250	09 CA170 40	09 CA570 40
300	09 CA170 50	09 CA570 50

Boxes of 1 piece + 1 dressing stone

### PLATINIUM 1 BLUE

Ø in mm	Self-adhesive	Magnetic
	Ref.	Ref.
200	09 CA140 20	09 CA540 20
230	09 CA140 30	09 CA540 30
250	09 CA140 40	09 CA540 40
300	09 CA140 50	09 CA540 50

### PLATINIUM 2 GREEN

Ø in mm	Self-adhesive	Magnetic
	Ref.	Ref.
200	09 CA150 20	09 CA550 20
230	09 CA150 30	09 CA550 30
250	09 CA150 40	09 CA550 40
300	09 CA150 50	09 CA550 50

### PLATINIUM 3 YELLOW

Ø in mm	Self-adhesive	Magnetic
	Ref.	Ref.
200	09 CA160 20	09 CA560 20
230	09 CA160 30	09 CA560 30
250	09 CA160 40	09 CA560 40
300	09 CA160 50	09 CA560 50

### PLATINIUM 4 RED

Ø in mm	Self-adhesive	Magnetic
	Ref.	Ref.
200	09 CA180 20	09 CA580 20
230	09 CA180 30	09 CA580 30
250	09 CA180 40	09 CA580 40
300	09 CA180 50	09 CA580 50

### ABRASIVE STONES FOR PLATINIUM

Type	Characteristics	Qty.	Ref.
Grain 120 for platinum 0 & 1	6 x 13 x 100 mm	2	98 59121 00
Grain 400 for platinum 2	6 x 13 x 100 mm	2	98 59401 00
Grain 600 for platinum 3 & 4	6 x 13 x 100 mm	2	98 59601 00

### GUIDANCE

In order to guarantee constant results, the CAMEO®DISK have to be periodically dressed by adequate abrasive stones.

#### Application Table

CAMEO®DISK	Equivalences	Application	Fluid/Liquid
Platinum 0 Brown Platinum 1 Blue Platinum 2 Green Platinum 3 Yellow Platinum 4 Red	Sic Paper P80 Sic Paper P120 Sic Paper P240 Sic Paper P600 Sic Paper P1200	Grinding hard material (≥ 120 HV)	Water

## GRINDING AND PREPOLISHING DISCS CAMEO®DISK

## CAMEO®DISK Silver, Gold &amp; Rhodium

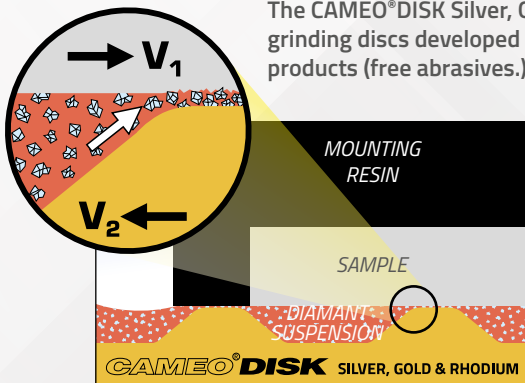

The CAMEO®DISK Silver, Gold & Rhodium discs are non-diamond grinding discs developed to be used with Bio DIAMANT® abrasive products (free abrasives.)

Combined with the latest products of the Bio DIAMANT® range, the NEODIA® diamond abrasives will allow treating all types of materials.

The patented CAMEO®DISK honeycomb structure allows the uniform distribution of the periodically pulverised diamond abrasive suspension. The use of the abrasive suspension is optimised, thereby reducing the diamond product's consumption.

There are three variants of CAMEO®DISK designed with differing hardness suited for different types of material prepolished.

## CAMEO®DISK SILVER

Boxes of 2 pieces + 1 dressing tool

Ø in mm	Self-adhesive		Magnetic	
	Ref.		Ref.	
200	09 CA120 20		09 CA520 20	
230	09 CA120 30		09 CA520 30	
250	09 CA120 40		09 CA520 40	
300	09 CA120 50		09 CA520 50	

## CAMEO®DISK GOLD

Boxes of 2 pieces + 1 dressing tool

Ø in mm	Self-adhesive		Magnetic	
	Ref.		Ref.	
200	09 CA130 20		09 CA530 20	
230	09 CA130 30		09 CA530 30	
250	09 CA130 40		09 CA530 40	
300	09 CA130 50		09 CA530 50	

## CAMEO®DISK RHODIUM

NEW

Boxes of 2 pieces + 1 dressing tool

Ø in mm	Self-adhesive		Magnetic	
	Ref.		Ref.	
200	09 CA100 20		09 CA500 20	
230	09 CA100 30		09 CA500 30	
250	09 CA100 40		09 CA500 40	
300	09 CA100 50		09 CA500 50	

## DIAMOND DRESSING TOOL FOR SILVER, GOLD &amp; RHODIUM

Characteristics	Qty.	Ref.
100 x 15 x 5 mm	1	98 BD001 00

## Application Table

CAMEO®DISK	Application	Fluid/Liquid
Silver	Medium to very hard ferrous alloys	6 to 15 µm diamond abrasives NEODIA® M, P or F
Gold	Soft non ferrous alloys	3 to 6 µm diamond abrasives NEODIA® M, P or F
Rhodium	Ceramics and Cermets	1 to 3 µm diamond abrasives NEODIA® M, P or F

CAMEO®DISK

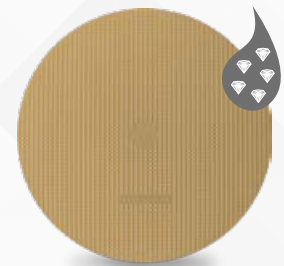

GUIDANCE

In order to guarantee constant results, the CAMEO®DISK have to be periodically dressed by appropriate abrasive dressing tool.

# TOUHLAM®

## TOUHLAM® polishing cloths & pads

LAM PLAN proposes a range of exclusive TOUCHLAM® polishing cloths and pads.

We conceive and produce all our TOUCHLAM® products, favouring quality of results through the selection of materials and treatments.

### Quality of results

The structure and the composition of a polishing support have a direct impact on the properties of the associated free abrasive during a polishing process. LAM PLAN has designed a range of polishing cloths & pads according to their capacity of optimising the abrasive functions in order to obtain an optimum quality of results.

### LAM PLAN guides you in your cloths and pads selection according to your results expectations

Example of a diamond abrasive, spread over different disc structures

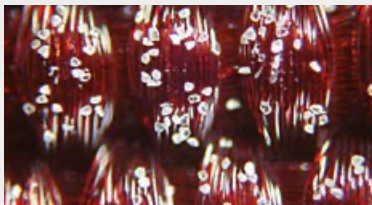

Taffeta woven synthetic fibres

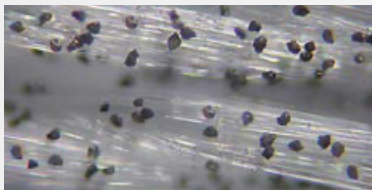

Satin woven natural fibres



Flocked viscose fibres

Application	TOUHLAM® cloths	Characteristics			
		SR*	Flatness	Finishing	Super Finishing
Fine grinding of soft materials Polishing of hard to extra hard material	2FC1	✓	✓		
Rough polishing on ductile material	2TT1	✓	✓		
Rough polishing on ductile material	2TT2	✓	✓		
Fine polishing (intermediary) on all materials Final polishing on hard materials	2TS3		✓	✓	
Fine polishing (intermediary) on all materials	2TS4		✓	✓	
Fine polishing (intermediary) on soft materials	3SE2		✓	✓	
Fine polishing (intermediary) on soft materials	3SA4		✓	✓	
Medium to fine polishing on semi-hard to hard (uncoated)	3TL1			✓	
Final polishing on semi-hard materials	3FV1				✓
Final polishing on soft to semi-hard materials	4FV3				✓
Final polishing (chemical/mechanical) on varied materials	4MP1				✓
Final polishing (chemical/mechanical) on varied materials	4MP2				✓

\*Stoke Removal

### Simplified use

The TOUCHLAM® cloths & pads are available in all standard diameters in two fixation modes: self-adhesive and magnetic.

The marking allows an easy identification. A tab is now integrated on the discs to facilitate the removal of the protective foil of self-adhesive cloths.

See all our fastening systems pages **FIXING ACCESSORIES**.



Disc identification marking

Self-adhesive cloth on FAS® 2 support

Magnetic cloth FMS® support

Tab



## POLISHING SUPPORTS

**TOUCLAM® 2FC1**

Impregnated non-woven fibres.  
Stoke removal, finishing on extra hard materials.  
Usable with diamond abrasives from 3 to 9 µm.

Ø mm	Qty.	Self-adhesive		Magnetic		X-LAM	
		Ref.	Ref.	Ref.	Ref.		
200	5 units	2FC10A02005	2FC10M02005	2FC10X02005			
230	5 units	2FC10A02305	2FC10M02305	2FC10X02305			
250	5 units	2FC10A02505	2FC10M02505	2FC10X02505			
300	5 units	2FC10A03005	2FC10M03005	2FC10X03005			
400	5 units	2FC10A04005					

**TOUCLAM® 2TT1**

Taffeta woven synthetic fibres.  
Stock removal and inherent flatness on difficult materials.  
Usable with diamond abrasives from 6 to 15 µm.

Ø mm	Qty.	Self-adhesive		Magnetic		X-LAM	
		Ref.	Ref.	Ref.	Ref.		
200	5 units	2TT10A02005	2TT10M02005	2TT10X02005			
230	5 units	2TT10A02305	2TT10M02305	2TT10X02305			
250	5 units	2TT10A02505	2TT10M02505	2TT10X02505			
300	5 units	2TT10A03005	2TT10M03005	2TT10X03005			
400	5 units	2TT10A04005					

**TOUCLAM® 2TT2**

Taffeta woven synthetic fibres.  
Stock removal and inherent flatness on difficult materials.  
High durability.  
Usable with diamond abrasives from 6 to 15 µm.

Ø mm	Qty.	Self-adhesive		Magnetic		X-LAM	
		Ref.	Ref.	Ref.	Ref.		
200	5 units	2TT20A02005	2TT20M02005	2TT20X02005			
230	5 units	2TT20A02305	2TT20M02305	2TT20X02305			
250	5 units	2TT20A02505	2TT20M02505	2TT20X02505			
300	5 units	2TT20A03005	2TT20M03005	2TT20X03005			
400	5 units	2TT20A04005					

**TOUCLAM® 2TS3**

Extra-thin satin woven natural fibres.  
Excellent inherent flatness and finishing, preservation of inclusions and edges, on all materials. Usable with diamond abrasives from 2 to 9 µm.

Ø mm	Qty.	Self-adhesive		Magnetic		X-LAM	
		Ref.	Ref.	Ref.	Ref.		
200	5 units	2TS30A02005	2TS30M02005	2TS30X02005			
230	5 units	2TS30A02305	2TS30M02305	2TS30X02305			
250	5 units	2TS30A02505	2TS30M02505	2TS30X02505			
300	5 units	2TS30A03005	2TS30M03005	2TS30X03005			
400	5 units	2TS30A04005					

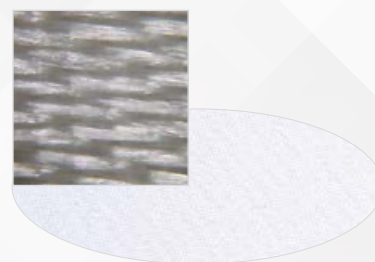
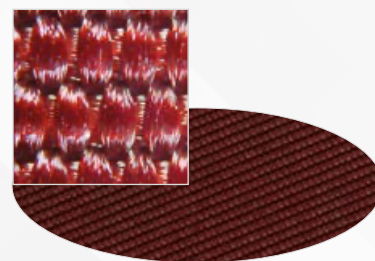
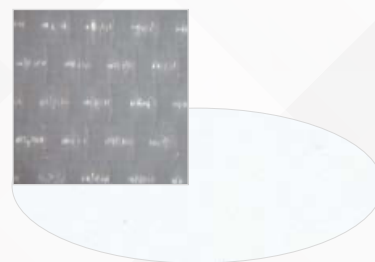

### TOUCLAM® 2TS4

Satin woven natural fibres.  
 Excellent finishing and flatness, preservation of edges, especially on sample composed of materials of various hardness or with coating.  
 High durability.  
 Usable with diamond abrasives from 1 to 6 µm.

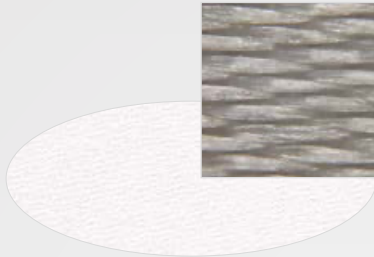

Ø mm	Qty.	Self-adhesive		Magnetic	X-LAM
		Ref.	Ref.	Ref.	Ref.
200	5 units	2TS40A02005		2TS40M02005	2TS40X02005
230	5 units	2TS40A02305		2TS40M02305	2TS40X02305
250	5 units	2TS40A02505		2TS40M02505	2TS40X02505
300	5 units	2TS40A03005		2TS40M03005	2TS40X03005
400	5 units	2TS40A04005			

### TOUCLAM® 3SE2

Woven synthetic silk fibres.  
 Finishing and flatness on soft materials.  
 Usable with diamond abrasives from 1 to 3 µm.

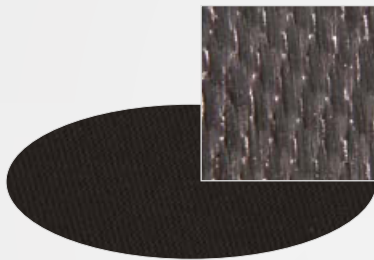

Ø mm	Qty.	Self-adhesive		Magnetic	X-LAM
		Ref.	Ref.	Ref.	Ref.
200	5 units	3SE20A02005		3SE20M02005	3SE20X02005
230	5 units	3SE20A02305		3SE20M02305	3SE20X02305
250	5 units	3SE20A02505		3SE20M02505	3SE20X02505
300	5 units	3SE20A03005		3SE20M03005	3SE20X03005
400	5 units	3SE20A04005			

### TOUCLAM® 3SA4

Soft composite synthetic fibres  
 Finishing on soft materials.  
 Usable with diamond abrasives from 0,25 to 3 µm.

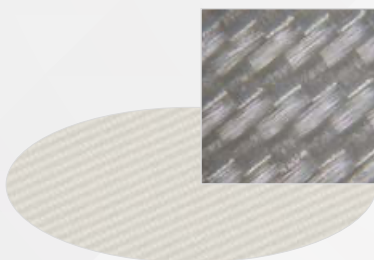

Ø mm	Qty.	Self-adhesive		Magnetic	X-LAM
		Ref.	Ref.	Ref.	Ref.
200	5 units	3SA40A02005		3SA40M02005	3SA40X02005
230	5 units	3SA40A02305		3SA40M02305	3SA40X02305
250	5 units	3SA40A02505		3SA40M02505	3SA40X02505
300	5 units	3SA40A03005		3SA40M03005	3SA40X03005
400	5 units	3SA40A04005			

### TOUCLAM® 3TL1

High resistant woven wool fibres.  
 Adapted for the finishing of non-mounted samples  
 High durability.  
 Usable with diamond abrasives from 3 to 6 µm.



Ø mm	Qty.	Self-adhesive		Magnetic	X-LAM
		Ref.	Ref.	Ref.	Ref.
200	5 units	3TL10A02005		3TL10M02005	3TL10X02005
230	5 units	3TL10A02305		3TL10M02305	3TL10X02305
250	5 units	3TL10A02505		3TL10M02505	3TL10X02505
300	5 units	3TL10A03005		3TL10M03005	3TL10X03005
400	5 units	3SA40A04005			

## POLISHING SUPPORTS

**TOUCLAM® 3FV1**

Semi-hard flocked short viscose fibres.

Super finishing, preservation of the inherent flatness on mounted hard materials.

Usable with diamond abrasives from 1 to 3 µm.

Ø mm	Qty.	Self-adhesive		Magnetic		X-LAM	
		Ref.	Ref.	Ref.	Ref.		
200	5 units	3FV10A02005	3FV10M02005	3FV10X02005			
230	5 units	3FV10A02305	3FV10M02305	3FV10X02305			
250	5 units	3FV10A02505	3FV10M02505	3FV10X02505			
300	5 units	3FV10A03005	3FV10M03005	3FV10X03005			
400	5 units	3FV10A04005					

**TOUCLAM® 4FV3**

Soft flocked long viscose fibres.

Super finishing on large variety of materials, including very soft materials.

Principally used with diamond abrasives from 0,25 to 3 µm but also with alumina suspension and colloidal silica.

Ø mm	Qty.	Self-adhesive		Magnetic		X-LAM	
		Ref.	Ref.	Ref.	Ref.		
200	5 units	4FV30A02005	4FV30M02005	4FV30X02005			
230	5 units	4FV30A02305	4FV30M02305	4FV30X02305			
250	5 units	4FV30A02505	4FV30M02505	4FV30X02505			
300	5 units	4FV30A03005	4FV30M03005	4FV30X03005			
400	5 units	4FV30A04005					

**TOUCLAM® 4MP1**

Microporous polyurethane foam.

Adapted to sensitive samples requiring an extreme super finish with chemical abrasives.

Usable with oxides or colloidal silica.

Ø mm	Qty.	Self-adhesive		Magnetic		X-LAM	
		Ref.	Ref.	Ref.	Ref.		
200	5 units	4MP10A02005	4MP10M02005	4MP10X02005			
230	5 units	4MP10A02305	4MP10M02305	4MP10X02305			
250	5 units	4MP10A02505	4MP10M02505	4MP10X02505			
300	5 units	4MP10A03005	4MP10M03005	4MP10X03005			
400	5 units	4MP10A04005					

**TOUCLAM® 4MP2**

Microporous polyurethane foam.

High thickness. High durability, usable in production process.

Usable with oxides or colloidal silica.

Ø mm	Qty.	Self-adhesive		Magnetic		X-LAM	
		Ref.	Ref.	Ref.	Ref.		
200	5 units	4MP20A02005	4MP20M02005	4MP20X02005			
230	5 units	4MP20A02305	4MP20M02305	4MP20X02305			
250	5 units	4MP20A02505	4MP20M02505	4MP20X02505			
300	5 units	4MP20A03005	4MP20M03005	4MP20X03005			
400	5 units	4MP20A04005					

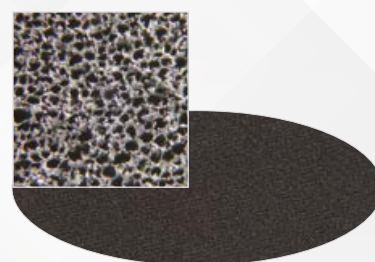
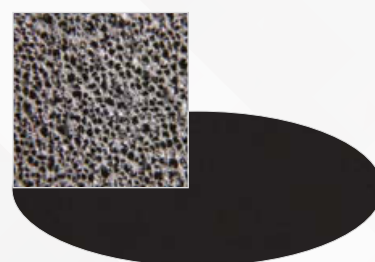
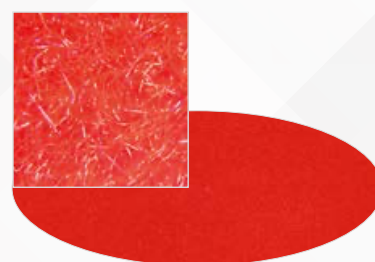
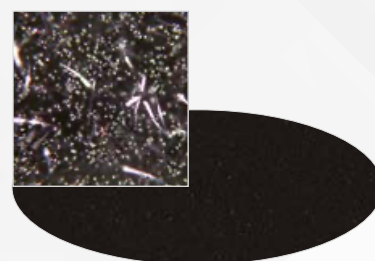



Monocrystalline diamond

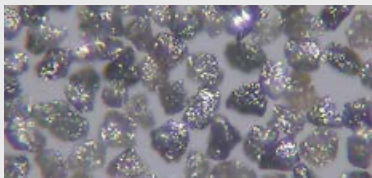

Polycrystalline diamond



Polycrystalline diamond on cloth



## BIO DIAMANT® abrasive suspension

For many years, the LAM PLAN R&D department has been committed to develop advanced products which are more user oriented and aimed to preserve the environment without compromising effectiveness.

Secured supply and total traceability.

Conformity to the REACH regulation.

LAM PLAN sets up all the arrangements needed for its application in order to guarantee the quality and availability of all its products over the long term. All the substances contained in our preparations comply with the REACH regulation's specifications. To facilitate your administrative formalities, all the Safety Data Sheets (SDS) of our products conform to the legislation in force it can be downloaded on [www.fds.lamplan.com](http://www.fds.lamplan.com)



### BIO DIAMANT® ABRASIVE SUSPENSION NEODIA®

In direct line with our famous Bio DIAMANT® range, the NEODIA® diamond abrasive suspension goes even further in terms of performance, efficiency and user comfort. The NEODIA® diamond suspension is a top-of-the-range product featuring exceptional performances.

#### Enhance roughness

The quality of the abrasive used, the tight criteria of calibration and concentration, as well as the use of a new generation of water-based binders allow better roughness results while preserving a high stock removal. The binder consistency allows the cutting action to start at the first seconds of usage.

#### Free of VOCs

The NEODIA® diamond suspensions are composed of a specific new generation binder; this liquid is free of Volatile Organic Compound (VOCs). The NEODIA® diamond suspensions is of course biodegradable at more than 70 % in accordance with the criteria of our Bio DIAMANT® label. Non-toxic and harmless, they are neutral, the user's work conditions are thus respected.

#### Biodegradable packaging: reduction of your activity's environmental impact

For the first time in the polishing industry a diamond suspension is packaged in a plastic bottle of vegetal origin which is 100% biodegradable and compostable according to the standard NF EN 13 432 (for 200 and 400 ml packaging).





## DIAMOND SUSPENSION

**BIO DIAMANT® ABRASIVE SUSPENSION NEODIA®M**

High performance suspension, high concentration of monocrystalline diamonds, biodegradable with no decantation.

200 ml with vaporiser			Refill 400 ml (sold without spray)
Type	µm	Ref.	Ref.
1/4 M	1/4	02 97460 80	02 97460 60
1 M	1	02 01460 80	02 01460 60
2 M	2	02 02460 80	02 02460 60
3 M	3	02 03460 80	02 03460 60
6 M	6	02 06460 80	02 06460 60
9 M	9	02 09460 80	02 09460 60
14 M	14	02 14460 80	02 14460 60

Refill 1 l (sold without spray)			Refill 2,5 l (sold without spray)
Type	µm	Ref.	Ref.
1/4 M	1/4	02 97460 20	02 97460 30
1 M	1	02 01460 20	02 01460 30
2 M	2	02 02460 20	02 02460 30
3 M	3	02 03460 20	02 03460 30
6 M	6	02 06460 20	02 06460 30
9 M	9	02 09460 20	02 09460 30
14 M	14	02 14460 20	02 14460 30

-3% off for the purchase of 3 products of the same reference

**BIO DIAMANT® ABRASIVE SUSPENSION NEODIA®P**

High performance suspension, high concentration of polycrystalline diamonds, biodegradable with no decantation.

200 ml with vaporiser			Refill 400 ml (sold without spray)
Type	µm	Ref.	Ref.
1/4 P	1/4	02 97469 80	02 97469 60
1 P	1	02 01469 80	02 01469 60
2 P	2	02 02469 80	02 02469 60
3 P	3	02 03469 80	02 03469 60
6 P	6	02 06469 80	02 06469 60
9 P	9	02 09469 80	02 09469 60
14 P	14	02 14469 80	02 14469 60

Refill 1 l (sold without spray)			Refill 2,5 l (sold without spray)
Type	µm	Ref.	Ref.
1/4 P	1/4	02 97469 20	02 97469 30
1 P	1	02 01469 20	02 01469 30
2 P	2	02 02469 20	02 02469 30
3 P	3	02 03469 20	02 03469 30
6 P	6	02 06469 20	02 06469 30
9 P	9	02 09469 20	02 09469 30
14 P	14	02 14469 20	02 14469 30

-3% off for the purchase of 3 products of the same reference





### BIO DIAMANT® NEODIA® F LIQUID

New generation of ready-to-use abrasive suspensions containing polycrystalline diamonds. The NEODIA® F is optimised for automatic dosage by spray (Venturi system). Its formulation and its price make it useful for intensive usage.

Type	µm	400 ml			1 l			2,5 l		
		Ref.			Ref.			Ref.		
1 F	1	02 01470 60	02 01470 20	02 01470 30						
3 F	3	02 03470 60	02 03470 20	02 03470 30						
6 F	6	02 06470 60	02 06470 20	02 06470 30						
9 F	9	02 09470 60	02 09470 20	02 09470 30						
14 F	14	02 14470 60	02 14470 20	02 14470 30						

-3% off for the purchase of 3 products of the same reference



**Diamond emulsion  
Does not crystallize**

### BIO DIAMANT® M.M.140 FINISHING LIQUID

High yield emulsion for the finishing of all materials.  
High concentration. Cleaning with solvent or detergent 742.

Characteristics	Type	Conditioning	Ref.
Diamond emulsion. Does not crystallize.	M.M.140	250 gr	02 MM140 00

### Manual distributors to be filled



Designation	Qty.	Ref.
200 ml biodegradable bottle + White vaporiser	1	08 00514 00
400 ml biodegradable bottle + Green spray	1	08 00513 00
Green spray	1	08 00503 00
500 ml PET bottle + white and red spray	1	08 00502 00

-5% off for the purchase of 3 products of the same reference

## DIAMOND SUSPENSION

**BIO DIAMANT® ABRASIVE SUSPENSION PULMATIC 310 AND 320P**

For large surface polishing and material sensitive to corrosion.

The Pulmatics are proposed in a practical packaging for a very good distribution of the product over the work surface. They are free of any propeller gas. Pulmatic 310 is an alcohol based monocrystalline diamond liquid of a medium concentration. The Pulmatic 320P is an alcohol based polycrystalline diamond liquid of a strong concentration.

**SERIE 310**

Characteristics	Concentration	Type	µm	Ref.
<b>Conditioning : Pulmatic</b>				
75 g Monocrystalline diamond Optimum distribution of the abrasive on the polishing support Alcohol base (free of water)	Medium	025 313	1/4	03 97313 00
		1 313	1	03 01313 00
		2 313	2	03 02313 00
		3 313	3	03 03313 00
		6 313	6	03 06313 00
		8 313	8	03 08313 00
		10 313	10	03 10313 00
		14 313	14	03 14313 00
		25 313	25	03 25313 00
		40 313	40	03 40313 00
<b>Conditioning : 1 Litre can</b>				
1 litre Monocrystalline diamond Alcohol base	Medium	025 313	1/4	03 97313 20
		1 313	1	03 01313 20
		2 313	2	03 02313 20
		3 313	3	03 03313 20
		6 313	6	03 06313 20
		8 313	8	03 08313 20
		10 313	10	03 10313 20
		14 313	14	03 14313 20
		25 313	25	03 25313 20
		40 313	40	03 40313 20

**SERIE 320P**

Characteristics	Concentration	Type	µm	Ref.
75 g Polycrystalline diamond Optimum distribution of the abrasive on the polishing support Alcohol base (free of water)	Strong	025 323P	1/4	03 97323 00
		1 323P	1	03 01323 00
		2 323P	2	03 02323 00
		3 323P	3	03 03323 00
		6 323P	6	03 06323 00
		8 323P	8	03 08323 00
		10 323P	10	03 10323 00
		14 323P	14	03 14323 00
25 323P	25	03 25323 00		



**-5% off for the purchase of 3 products of the same reference**

Products subject to shipping restrictions.



Does not crystallize

## Finishing liquids SUPERFINISH

### FINAL FINISHING LIQUID

Aqueous suspension of non-agglomerated nanometric silica stabilised in an alkaline medium. Used to carry out super finishing, to obtain ultra-low roughness. Very easy-to-use and applicable on all types of materials. Does not crystallize.

**Usage recommendation:** dilute 10 to 20% in water.

Characteristics	Type	Conditioning	Ref.
Final polishing on polishing cloth.	Final liquid	500g	05 NL008 00
All materials.	Final liquid	5 litres	05 NL008 40



### L1 FINISHING LIQUID

Final polishing suspension specially formulated for mechano-chemical polishing. During usage, the active substances of the solution embrittle the surface to be polished, thereby optimising the efficiency of the abrasive grains. Allows combining performance (stock removal) and polishing quality. Recommended for titanium and its alloys.

**Usage recommendation:** ready-to-use preparation.

Characteristics	Type	Conditioning	Ref.
Final polishing on polishing cloth.	L1 liquid Titanium	1 litre	05 NL01 00
All materials.			



### L2 FINISHING LIQUID

Composite solution of ceramic oxides and silica. Ideal to prepare your surface before the super finishing step. Recommended for the polishing of aluminium and its alloys.

**Usage recommendation:** ready-to-use preparation.

Characteristics	Type	Conditioning	Ref.
Final polishing on polishing cloth.	L2 liquid Aluminium	1 litre	05 NL02 00
All materials.			



### ALPLAN LIQUIDS

New final polishing solutions composed of aluminium oxides of a very high purity. These alumina preparations are subjected to a pushed de-agglomeration treatment; which result excellent polishing quality. Easy-to-use, ALPLAN solutions are usable on all types of materials.

**Usage recommendation:** use pure or diluted up to 50% with water.

Characteristics	Grain sizes	Conditioning	Ref.
	0,05 µm	1 litre	05 AP005 00
ALPLAN is used pure or diluted up to 50% with water	0,25 µm	1 litre	05 AP025 00
	1 µm	1 litre	05 AP100 00
	3 µm	1 litre	05 AP300 00

## DIAMOND SUSPENSION

**Bio DIAMANT® Stick Series 122 and 123P****For manual use and control of consumption**

The diamond paste is distributed according to a precise dosage thanks to a drum graduated every 0.2 g. The diamond paste is repetitively loaded on the polishing cloth without any contact with fingers. The pastes and sticks are used with 702 and 704 type lubricants. The product's colour marking facilitates its identification.

**The dosing sticks series 122:**

are composed of a monocrystalline diamond paste of a strong concentration.

**The dosing stick series 123P:**

are composed of a polycrystalline diamond paste of a strong concentration.



Characteristics	Concentration	Type	µm	Ref.
<b>SERIE 122</b>				
10 g Monocrystalline diamond Consumption control Easy distribution Coloration by grain size Water or alcohol cleaning	Strong	025 122	1/4	01 97122 00
		1 122	1	01 01122 00
		3 122	3	01 03122 00
		6 122	6	01 06122 00
		9 122	9	01 09122 00
		15 122	15	01 15122 00
<b>SERIE 123P</b>				
10 g Polycrystalline diamond Consumption control Easy distribution Water or alcohol cleaning	Strong	025 123P	1/4	01 97123 00
		1 123P	1	01 01123 00
		3 123P	3	01 03123 00
		6 123P	6	01 06123 00
		9 123P	9	01 09123 00
		15 123P	15	01 15123 00

-5% off for the purchase of 3 products of the same reference

**GUIDANCE****Indicative quantities necessary to load a new cloth**

Cloth Ø mm	150	200	250	300	400
Woven	0,2 g	0,2 g	0,4 g	0,4 g	0,6 g
Flocked	0,3 g	0,4 g	0,5 g	0,6 g	0,7 g



## Bio DIAMANT® pastes Serie 100

### Unique abrasive compounds

Designed for all grinding and polishing work, the Bio DIAMANT® Pastes contain a diamond powder free of any impurity, guaranteeing its cutting power. The perfectly calibrated grains are uniformly suspended in chemically pure ingredients.

A formulation which provides a more uniform and more fluid abrasive film which allows an immediate abrasion of the part to be polished.

The concentration of the pastes has a direct effect on the polishing's execution rate: a high concentration is the guarantee of a high yield.



Characteristics	Concentration	Type	µm	Ref.
10 g. Monocrystalline diamond For all materials Cleaning with water or alcohol Coloration by grain size	Strong	010 103	1/10	01 99103 00
		025 103	1/4	01 97103 00
		1 103	1	01 01103 00
		2 103	2	01 02103 00
		3 103	3	01 03103 00
		6 103	6	01 06103 00
		8 103	8	01 08103 00
		14 103	14	01 14103 00

-5% off for the purchase of 3 products of the same reference

Characteristics	Concentration	Type	µm	Ref.
10g. Monocrystalline diamond For all materials Cleaning with water or alcohol Coloration by grain size	Very strong	1 105	1	01 01105 00
		2 105	2	01 02105 00
		3 105	3	01 03105 00
		6 105	6	01 06105 00
		8 105	8	01 08105 00
		14 105	14	01 14105 00

-5% off for the purchase of 3 products of the same reference



### Reading the type

<b>Exemple:</b>	Paste type:	6 103
	Grain size:	6 microns
	Series:	100
	Concentration:	3 (strong)
		5 (very strong)

## LUBRICANTS

## Lubricant M.M.702

Lubricant to be used to optimise polishing with Bio DIAMANT® diamond pastes series 100 and sticks series 122 & 123P. Ready-to-use, it ensures an excellent dispersion of the abrasive and prevents the risks of heating the material during polishing.

This lubricant is easily cleaned with water, alcohol or aqueous detergents (detergent 742).

Characteristics	Conditioning	Ref.
Recommended as an addition to LAM PLAN diamond pastes and sticks	1 litre	07 MM702 30
Water base	5 litres	07 MM702 40



## Lubricant M.M.704

Alcohol-based lubricant perfectly suitable to polish samples which are sensitive to corrosion. Ready-to-use, it ensures a strong cooling during the work.

This lubricant is particularly recommended for the polishing of ductile materials.

For cleaning, it is recommended to use the detergent 742 or alcohols like isopropyl alcohol.

Characteristics	Conditioning	Ref.
Recommended as an addition to LAM PLAN diamond pastes and Pulmatic Alcohol base diamond liquid	1 litre	07 00704 30
	5 x 1 litre*	07 00704 40

\*Packaging related to transport restrictions



## Booster for CAMEO®DISK Platinum

Booster fluid is a new lubricant especially developed to be applied on the CAMEO®DISK Platinum during the polishing step. Its specific formulation facilitates the use of the CAMEO®DISK Platinum 0, 1, 2, 3 and 4.

Ready-to-use, this new lubricant maintains the efficiency of the CAMEO®DISK constant in time and avoids the use of abrasive stone to regenerate the disc.

The main advantages are:

- Improves the efficiency of the CAMEO®DISK
- Keeps the efficiency constant in time
- Reduces water consumption
- Universal use, can be used on all kind of material
- Ready to use.

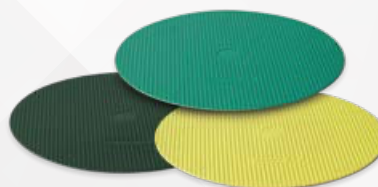

Characteristics	Conditioning	Ref.
Ready to use lubricant fluid	5 litres	07 BP030 40





## Metallographic reagents

Etching reagents are used to examine the structure of metallic materials. The objective of the micrographic analysis is to highlight the structure of the material (inclusions, grain boundaries, phases, ...) using an optical microscope.

These reagents act either by preferential chemical attack, or by coloration of certain constituents compared to others.

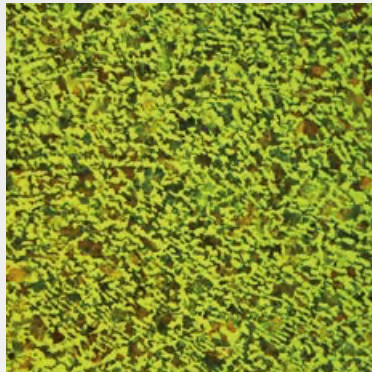

Steel etching nital 5 %

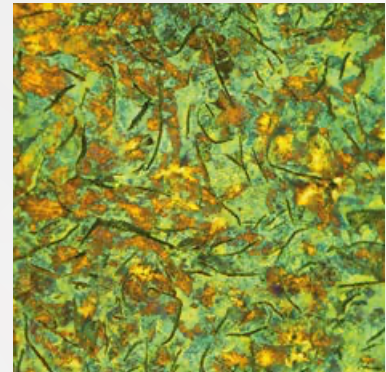

Lamellar cast iron nital attack 5 %

Packaging: 1 liter

Recommendations	Highlighting	Ref.
<b>NITAL 5% REAGENT</b>		
<p>Room temperature, a few seconds</p> <ul style="list-style-type: none"> <li>- Iron and ferrous alloys (cast iron and steel)</li> <li>- Magnesium and its alloys</li> <li>- Tin and its alloys</li> <li>- Pure titanium</li> <li>- Cadmium and its alloys</li> </ul>	<ul style="list-style-type: none"> <li>- Welding of steels</li> <li>- Ferrite grain boundaries and constituents</li> <li>- Segregation and case hardening zones</li> </ul>	08 RN050 20
<b>NITRIC ACID 10% REAGENT</b>		
<p>Room temperature</p> <ul style="list-style-type: none"> <li>- Steels</li> </ul>	<ul style="list-style-type: none"> <li>- Phases on ferritic welds in steels</li> </ul>	08 RR090 20
<b>MURAKAMI REAGENT</b>		
<p>Room temperature or hot, 60 seconds</p> <ul style="list-style-type: none"> <li>- Iron and ferrous alloys (cast iron and steel)</li> <li>- Tungsten alloys</li> </ul>	<ul style="list-style-type: none"> <li>- Carbide highlighting: to blacken carbides, Use at 80°C to boiling under fume hood.</li> <li>- Weakly revealed <math>\Sigma</math> (sigma) phase after 3 min at room temperature.</li> </ul>	08 RR030 20
<b>KALLING N° 1 REAGENT</b>		
<p>Room temperature</p> <ul style="list-style-type: none"> <li>- Martensitic stainless steels</li> </ul>	<ul style="list-style-type: none"> <li>- To color in black the martensite of stainless steels.</li> <li>- To color the ferrite</li> <li>- To highlight segregations and austenite grain boundaries.</li> </ul>	08 RR040 20
<b>OBERHOFFER REAGENT</b>		
<p>Room temperature, 20 seconds</p> <ul style="list-style-type: none"> <li>- Non-alloyed steels</li> <li>- Low-alloyed steels</li> </ul>	<ul style="list-style-type: none"> <li>- Primary structures (fiber layer)</li> <li>- Make phosphorus accumulations visible</li> </ul>	08 RR050 20



## METALLOGRAPHIC REAGENTS

Packaging: 1 liter		
Recommendations	Highlighting	Ref.
<b>KELLER REAGENT</b>		
<b>Room temperature</b> - Aluminium and its alloys, - Titanium alloys	- Highlighting of the phases	08 RR060 20
<b>KROLL'S REAGENT</b>		
<b>Room temperature</b> - Aluminium and its alloys - Titanium alloys (mainly Ti-Al-V(-Sn))	- Highlighting of the phases	08 RR070 20
<b>MARBLE REAGENT</b>		
<b>Room temperature, 10 seconds</b> - Austenitic steels - High temperature steels - Cobalt superalloys	- Highlighting of the austenitic phase nuances - Attack of the $\Sigma$ phase (sigma) - Highlighting of the grain structures	08 RR080 20
<b>PICRAL-2 REAGENT</b>		
<b>Room temperature, few seconds</b> - Iron and ferrous alloys (cast iron and steel)	- Structures composed of ferrite - Reveal carbides. - Reveal fine microstructures. - Revealing the grain boundaries	08 RR020 20
<b>KLEMM I REAGENT</b>		
<b>Room temperature</b> - Non-alloy and low-alloy steels - Cast iron - Manganese and zinc steels - Brass and bronze - Low alloyed zinc	<b>Staining Reagent:</b> - On steels: 40 to 100 sec to color the ferrite, blue and brown depending on the orientation of the grain. Carbides, cementite and phosphides are not colored and remain white - On brass and bronze: 3 min to color $\beta$ phase, 10 to 60min for $\alpha$ phase - On zinc alloys: 30 sec	08 RR010 10
<b>KLEMM II REAGENT</b>		
<b>Room temperature</b> - Manganese alloys - Copper and its alloys (brass and bronze) - Tin and its alloys	To reveal the austenitic phase of manganese alloys. Reagent for staining and analyzing soft solder: Brass: 6 min for $\alpha$ phase Tin and alloys : 60 to 90 sec	08 RR010 20
<b>10% SODA SOLUTION</b>		
<b>Room temperature or 5 sec. at 70°C</b> For all aluminum and its wrought alloys.	Aluminium welding Phase identification	08 RS100 20

Products subject to shipping restrictions.

# LITHOPREPARATION



IMPREGNATION

NEW

## M.M.818 vacuum impregnator device

Compact vacuum mounting unit for impregnation of porous materials and bubble-free mounting with epoxy resins type 603. The M.M.818 has a large capacity vacuum chamber of 160 mm diameter and is equipped with a resin distribution system. A vacuum gauge on the front panel allows the vacuum level to be monitored and the various vacuum cycles to be controlled manually.



Technical Data	M.M.818
Vacuum level	- 650 mm-Hg
Inner diameter base	160 mm
Useful height of vacuum tank	160 mm
Dimensions W x H x D	480 x 400 x 400 mm
Vacuum pump dimensions (W x H x D)	140 x 210 x 240 mm
Power supply	230 V - 50 Hz single phase
Weight	10,10 kg
Weight vacuum pump	7,25 kg
Reference	08 00818 00

## PE128 precision sample holder for thin slides

The LAM PLAN PE128 specimen holder is used to hold several thin slides by vacuum suction during a lapping operation. This sample holder guarantees a high level of parallelism.

The precision and robustness of this device allow it to meet the specific demands of research laboratories as well as the constraints of production laboratories.

- Adjustable thickness of the thin blades and automatic parallelism.
- The set includes 1 micrometer ruler, 1 vacuum pump and 1 sample holder Ø 120 mm.
- Compatible thin blades : 6x 30x45 ou 6x 28x48 - 1x 120x45 + 2x 28x48 (or 2x 30x45) 1x 120x90 - 1x 60x80 + 2x 28x48 (or 2x30x45) - 2x 60x80 - 4x 24x27 - 4x Ø1 inch.

NEW



Technical Data	PE128
Accuracy of the adjustment ring	200 µm per rotation
Useful internal diameter	128 mm
Dimensions (H x Ø)	210 x 144 mm
Weight	6,27 kg

LAM PLAN presents you its new developments resulting from the collaboration of our TEST CENTRE with reference LITHO-PREPARATORS.

An offer composed of equipment and consumables dedicated to the preparation of geological substrates and in particular the realization of thin sections.

## ROUGHING AND POLISHING

### M.M.8400 with PE128

#### Grinding and thickness adjustment

The LAM PLAN M.M.8400 grinding machine combined with the PE128 mounting is the ideal equipment for making reference faces or for precise thicknessing. Combined with the AQUA LAM® range of Sic abrasives from roughing to grinding it is a reliable and versatile solution for preparing your mineral samples.



### MASTERLAM® 3.0 with thin slide holder

#### Finishing polish

The MASTERLAM® 3.0 automatic polisher with the new thin blade holders will allow you to achieve the final polishing of your samples.

To achieve your goals we offer TOUCHLAM® polishing mounts, NEODIA® BioDIAMANT® abrasives and SUPERFINISH superfinishing liquids.



MASTERLAM® 3.0 GEOLOGICAL POLISHING  
Reference 60 ML30M 00

NEW



Sample holder  
3 x 45x60 mm

NEW



Sample holder  
6 x 30x45 mm



# GENERAL TERMS AND CONDITIONS OF SALE

## 1. Application of General Terms & Conditions of Sale

All orders placed with Lam Plan imply acceptance by the client, without any reservation, of all the General Terms and Conditions of Sale as set forth here below.

Client orders shall be registered by Lam Plan only in accordance with these General Terms and Conditions of Sale, regardless of contrary provisions, if any, that may be contained in the purchase order or in the general terms and conditions of purchase of the client, unless they have been expressly accepted in writing by Lam Plan.

The waiver by Lam Plan of one or more provisions of these General Terms and Conditions of Sale does not imply the waiver of any other provisions thereof which shall remain effective and binding upon the client.

The present General Terms and Conditions of Sale may be amended at any time without prior notice by Lam Plan, with the amendments thereafter being applicable to all subsequent orders.

The Client acknowledges being fully aware that their agreement with respect to the contents of these General Terms and Conditions of Sale does not require their signing of this document.

## 2. Orders

The sale shall be deemed to have been completed only upon acceptance of the order from the client by Lam Plan.

The products shall be supplied and invoiced at the relevant price rates in effect at the time of placing of the order or, where applicable, in accordance with the specific commercial proposal addressed to the client and accepted by them.

Any eventual amendments to the order subsequently made by the client shall be taken into account, only within the limits of the possible options available and at the sole discretion of Lam Plan, and provided that they have been notified in writing to Lam Plan at least fifteen days prior to the date scheduled for delivery, accompanied with the issuance of a new specific purchase order duly signed by the client, including, where appropriate, a price adjustment.

## 3. Prices

The prices indicated in the Lam Plan catalogues are provided for illustrative purposes only and are not binding upon Lam Plan.

Appropriate invoices shall be issued in accordance with the price rates in force on the date of the order.

Unless otherwise specified in writing, all rates and prices are expressed in Euro and quoted net, ex works, exclusive of taxes and packaging.

As a consequence, the client shall bear all costs related to VAT at the applicable rate, transportation costs, fees and duties as well as any expenses associated with insurance.

Special pricing terms and conditions may be applicable depending upon the specifications requested by the client, particularly concerning the specific modalities, terms and timelines of delivery, timing and terms and conditions of payment.

In this event a special commercial offer shall be prepared and sent to the client by Lam Plan.

## 4. Payment

The quoted price shall be payable in full in one single payment within a period of thirty days from the date of issue of the invoice, end of the month.

In case of late payment, Lam Plan may suspend any pending orders without prejudice to the application of late payment penalty fees that will be due as of the day following the settlement date as indicated on the invoice, applicable on the full amount/s due, calculated at three times the interest rate in effect on the date of implementation of this provision and applied by the European Central Bank.

Moreover, and in accordance with Article L 441-6 of the Code de Commerce (French Commercial Code), in addition to late payment penalties, the client shall be required to pay a lump sum amount of 40 Euros for recovery costs, with Lam Plan however, reserving the right to seek additional compensation on upon presentation of supporting documentation, corresponding to the recovery costs incurred, in excess of the lump sum amount.

## 5. Retention of Ownership Title

Lam Plan retains the right to reserve ownership title of the goods delivered to the client until payment has been made in full, inclusive of principal, interest and ancillary costs.

However, the risks relating to the goods shall be transferred to the client immediately upon delivery and, for the entire period of time corresponding to the Retention of Ownership Title by Lam Plan.

Client shall agree, therefore, to take out appropriate insurance policies to provide adequate coverage against the risk of loss, theft or destruction of the goods prior to full payment being made.

Without prejudice to any subsequent action or claim for compensation for damages, Lam Plan may terminate the sale, with the aforementioned goods being subject to repossession in totality by Lam Plan without prior notice provided thereof, in the event of non payment of any invoices that become due.

The client shall refrain from pledging as collateral or assigning ownership of the said goods until such time as they have fully settled the payment corresponding to the price thereof.

In the event of the client becoming the subject of bankruptcy proceedings or getting involved in any other event making it impossible to pay for the goods delivered by Lam Plan and where the goods were to be sold in part or whole by the client to a subsequent purchaser, without the subsequent purchaser being discharged from the liability of paying the sale price, with respect to the client, the client shall agree to promptly provide Lam Plan with all information necessary for Lam Plan to make any eventual claim on the goods, against the corresponding claim related to the sale price still owed by the subsequent purchaser.

## 6. Delivery

Delivery dates and time lines are purely indicative, provided only for informative purposes and as such, are in no way guaranteed.

In this regard, Lam Plan's obligation is an obligation in terms of means and not an obligation in terms of result.

As a consequence, possible delays in delivery therefore may not be considered grounds for the cancellation of the order, refusal of the goods, the allocation of penalties or any claim for compensatory damages.

Lam Plan shall therefore not be held responsible for any delays in or suspension of delivery, errors, disruptions attributable to their service providers, contractors and / or subcontractors, or due to any unforeseeable fortuitous circumstances or force majeure events, as recognised by the French courts.

The Lam Plan warehouses shall constitute the place of delivery.

This rule shall not be subject to any derogation whatsoever on account of the management, in whole or in part, of the transportation of goods by Lam Plan.

In such a case, Lam Plan shall act in the capacity of a mere agent of the client, with the transportation risks being entirely borne by the client.

Unless otherwise stipulated in relevant provisions, the goods shall be transported at the sole risk and expense of the client, by carrier, and shall be delivered to the address indicated by them in the purchase order.

The client shall be responsible for checking and verifying the condition of the goods upon receipt.

In the event of goods that are missing or that have been damaged in transit, the client shall undertake to express all the necessary reservations on the delivery note or transportation waybill, upon receipt of the said goods.

In addition, these reservations must be confirmed to the carrier in accordance with Article L 133-3 of the French Commercial Code, in writing, within three days following the receipt of goods, by registered letter with acknowledgment of receipt.

It shall be up to the client to exercise their rights in respect of any eventual claims against the carrier or carriers.

#### **6bis. Return**

Returns of goods for other reasons than non-conformity may be made within 15 days from the date of receipt of the delivery, subject to prior written notification by the customer.

The shipping or return costs are at the customer's expense. The return of the product(s) must be made in its original packaging and in good condition. All damaged, spoiled, incomplete or soiled products will not be refunded. LAM PLAN reserves the right to decide whether or not to issue a refund after quality control.

#### **7. Limited warranty**

New materials and equipment sold by LAM PLAN are guaranteed against any manufacturing risk for a period of one year from the date of invoice of the delivered material.

The purchaser is obliged to check the condition of the materials and equipment immediately after receipt and must notify LAM PLAN within 10 days after receipt if any defects are discovered.

LAM PLAN then undertakes, at its own discretion, to remedy any malfunction during the warranty period, either by repairing the product, replacing the product or refunding the purchase price, provided that the materials and equipment have been used in normal conditions, with LAM PLAN brand products and with regular maintenance.

The warranty does not cover repairs due to:

- the use of materials supplied by the customer or of a design imposed by him;

- incidents due to fortuitous events or force majeure, normal wear and tear of the product, negligence of the customer, lack of supervision or maintenance, or non-conforming, inappropriate or improper use;

- storage or packaging conditions that do not comply with professional rules and practices or with the specificities of the product;

- defects in assembly or implementation by the customer, or the actions of a third party;

- modifications or repair work carried out by the customer or a third party without the prior written authorization of LAM PLAN.

Furthermore, LAM PLAN does not grant any warranty regarding:

- the actual performance of the Products, other than their ability to meet the specifications set by LAM PLAN;

- the electronic components of the Products or their associated accessories, including but not limited to printed circuit boards and integrated circuits.

The customer is obliged to give LAM PLAN the necessary time and means to carry out the necessary repairs and/or replacements, failing which LAM PLAN's warranty will no longer be due to the customer.

LAM PLAN's warranty is, therefore, strictly limited as indicated above.

By express agreement, all damages of any nature whatsoever resulting from damage inherent in the defects of the goods are excluded from the guarantee.

#### **9. Copyright**

Ownership of copyrights for all documents in all classes is retained by Seller. Buyer is granted a license to make, without further approval by Seller, a limited number of copies, in whole or in part, of a document, so long as the copied portion includes the applicable copyright and trademark statements found on the original document.

The reproduction for promotional purposes of all or part of texts, images and graphic elements is strictly prohibited without the express permission of LAM PLAN.

#### **10. Applicable Law**

All provisions of these General Terms and Conditions of Sale are exclusively subject to French law with respect to the interpretation and enforcement thereof.

#### **11. Assignment of Jurisdiction**

Any dispute arising from the interpretation and / or enforcement of these General Terms and Conditions of Sale shall be subject to a process of discussion and consultation with a view to achieving an amiable settlement.

Failing such a settlement being obtained within a period of two months from the date the dispute was notified and acknowledged, the dispute shall be brought before the Tribunal de Commerce de Paris (Commercial Court of Paris) who will have sole jurisdiction in the matter.

This clause shall be applicable, including in the event of summary proceedings, fixed date petition hearings and proceedings, incidental claims, plurality of defendants or third parties, and without the possibility of any hindrance thereto arising from the jurisdiction assignment clauses contained in the client's documents.



*POLISHING TECHNOLOGY®*

## BY YOUR SIDE EVERYWHERE IN THE WORLD



Algeria  
Australia  
Austria  
Belgium  
China  
Czech Republic  
France  
Germany  
Greece

Hungary  
India  
Indonesia  
Israel  
Italy  
Japan  
Korea  
Malaysia  
Norway

Poland  
Portugal  
Russia  
Saudi Arabia  
Singapore  
Spain  
Sweden  
Switzerland  
Taiwan

Thailand  
The Netherlands  
Turkey  
United Arab Emirates  
United Kingdom  
United States

Distributed by



LAM PLAN SA  
7 rue des Jardins - BP15  
74240 GAILLARD - France  
Tel. +33 (0)4 50 43 96 30

[www.lamplan.com](http://www.lamplan.com)